

# STS/EACTS Latin America Cardiovascular Surgery Conference

November 15-17, 2018

Hilton Cartagena | Cartagena, Colombia



The Society  
of Thoracic  
Surgeons



EACTS  
European Association for Cardio-Thoracic Surgery

## Aortic valvuloplasty: Ozaki Procedure



# How do I perform the Ozaki procedure in children

Pedro J. del Nido, MD  
Boston Children's Hospital  
Harvard Medical School



No Disclosures



# Case: 16 y/o AS/AR

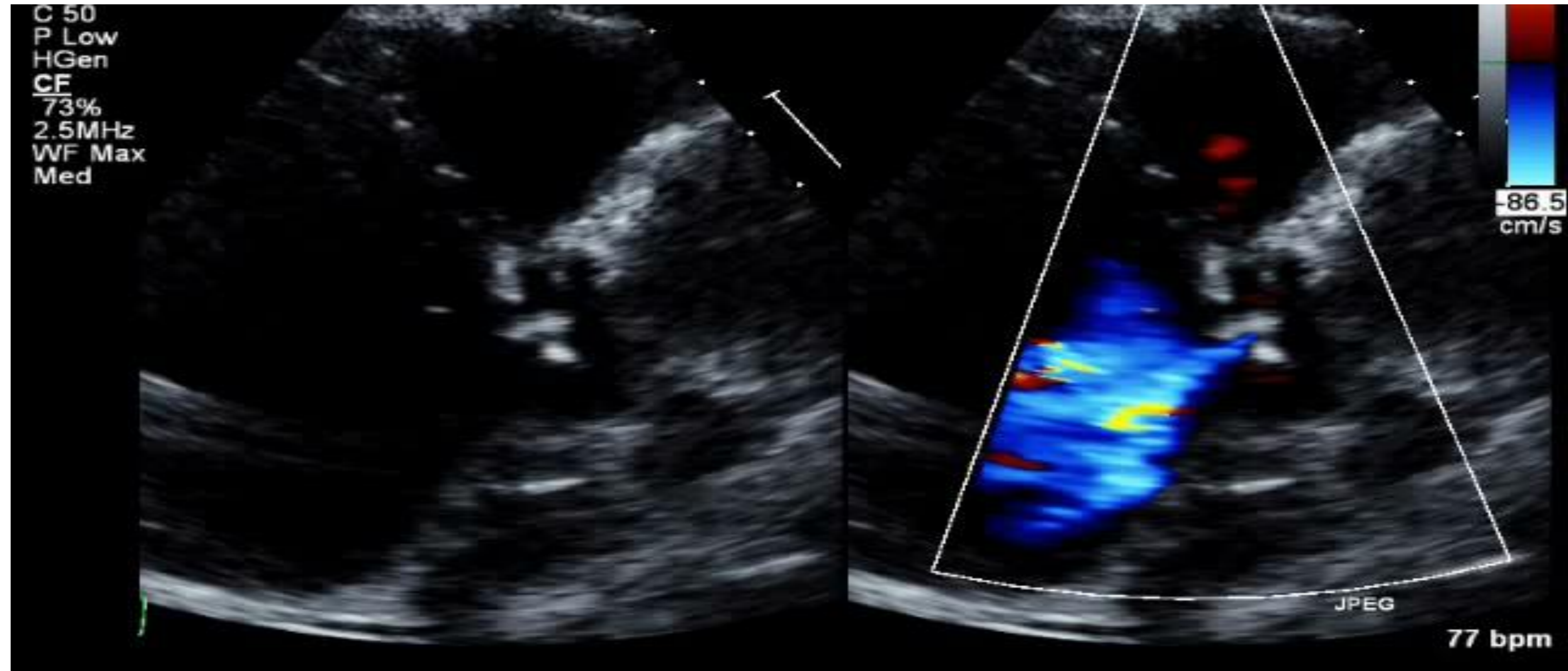

# Results of Ao valve repair in teens (BCH)

**2005- 2015**  
**median age 15yrs. (11.5-22yrs.) n=121;**

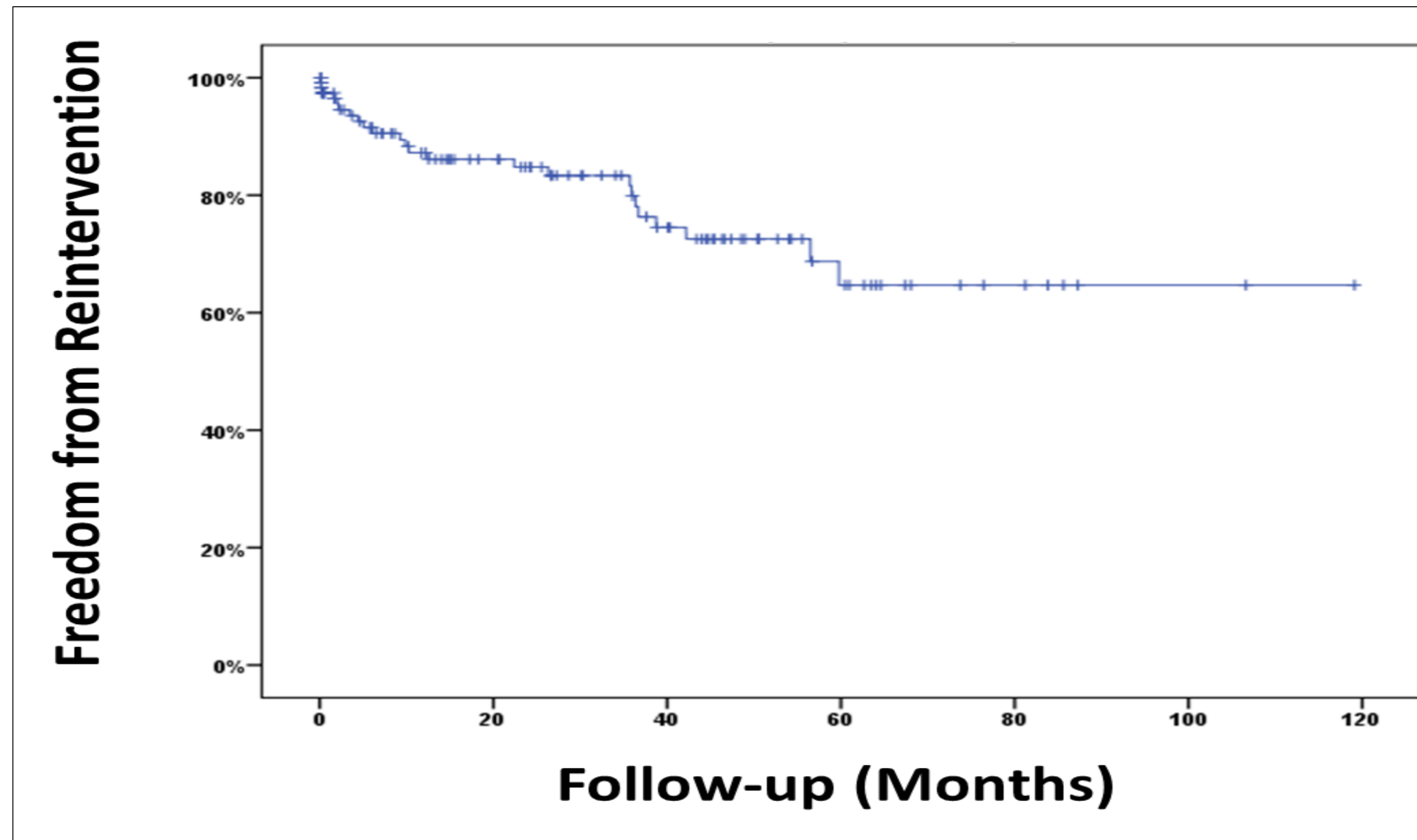

# Aortic Valve Reconstruction: The Ozaki Technique

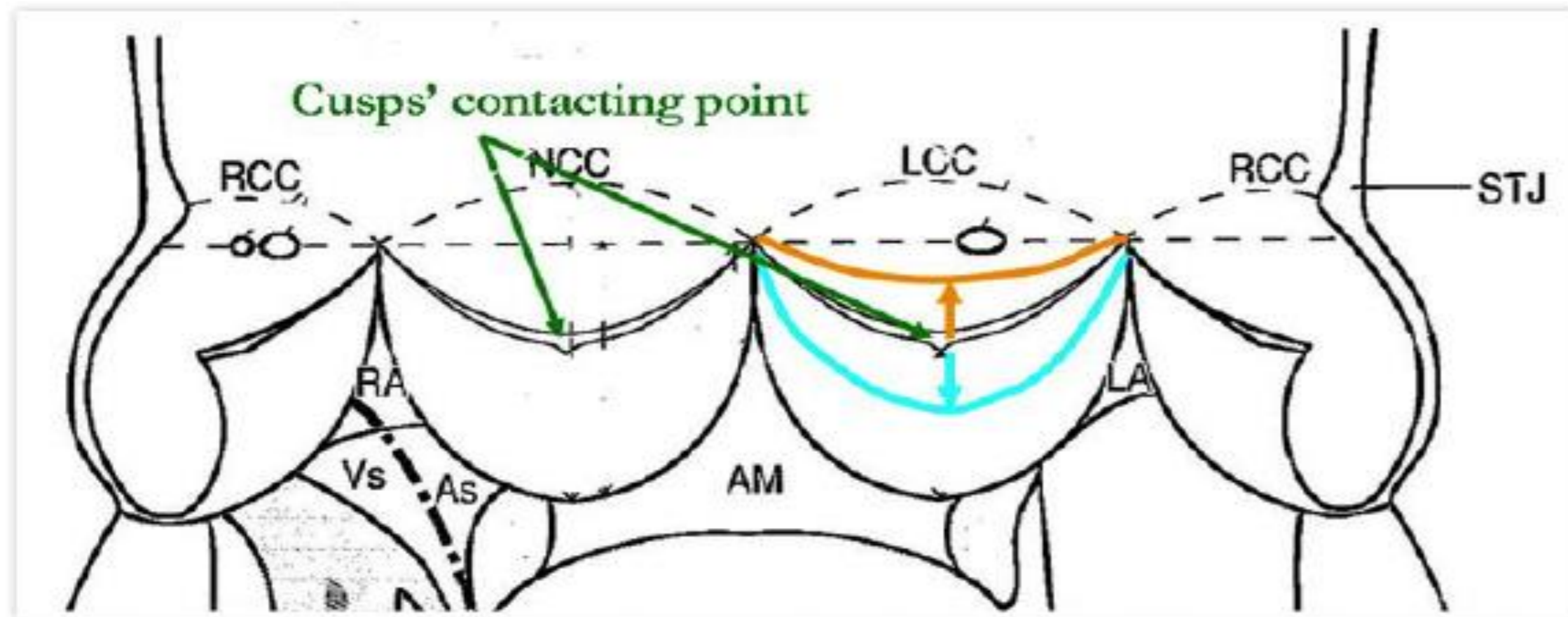

Fig. 2

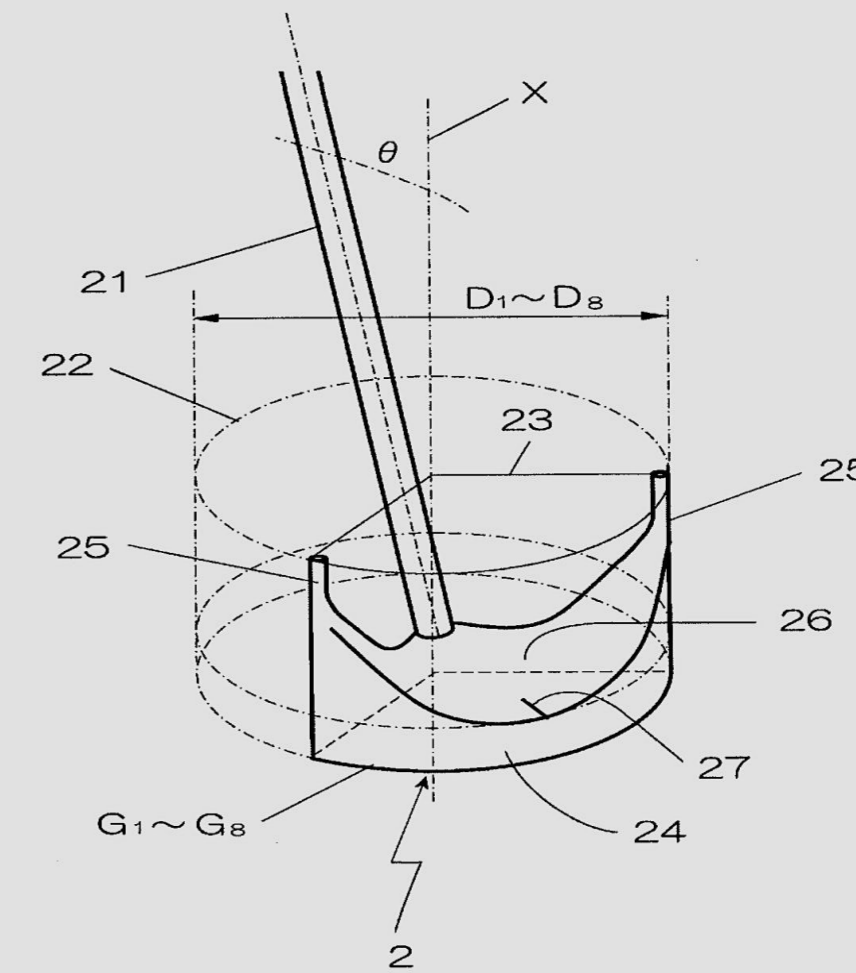
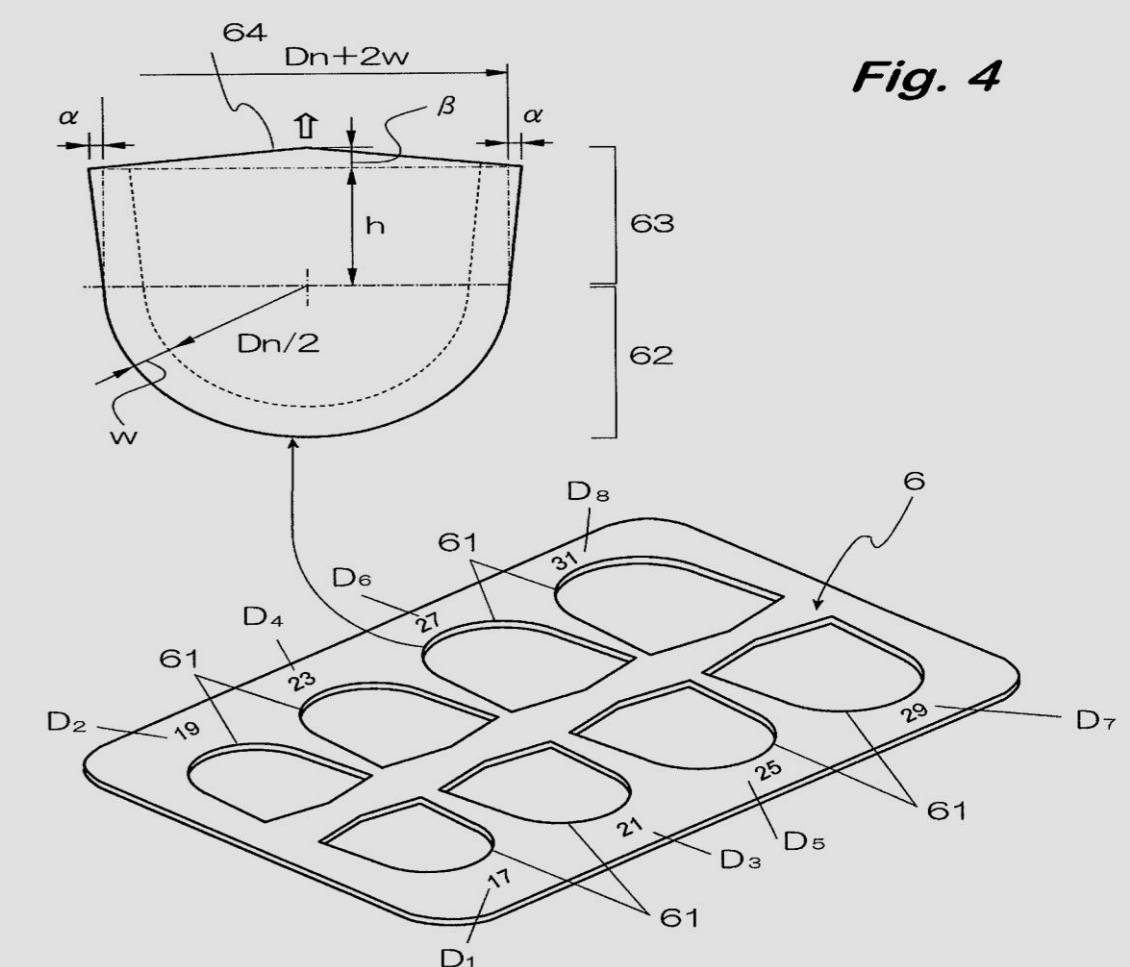
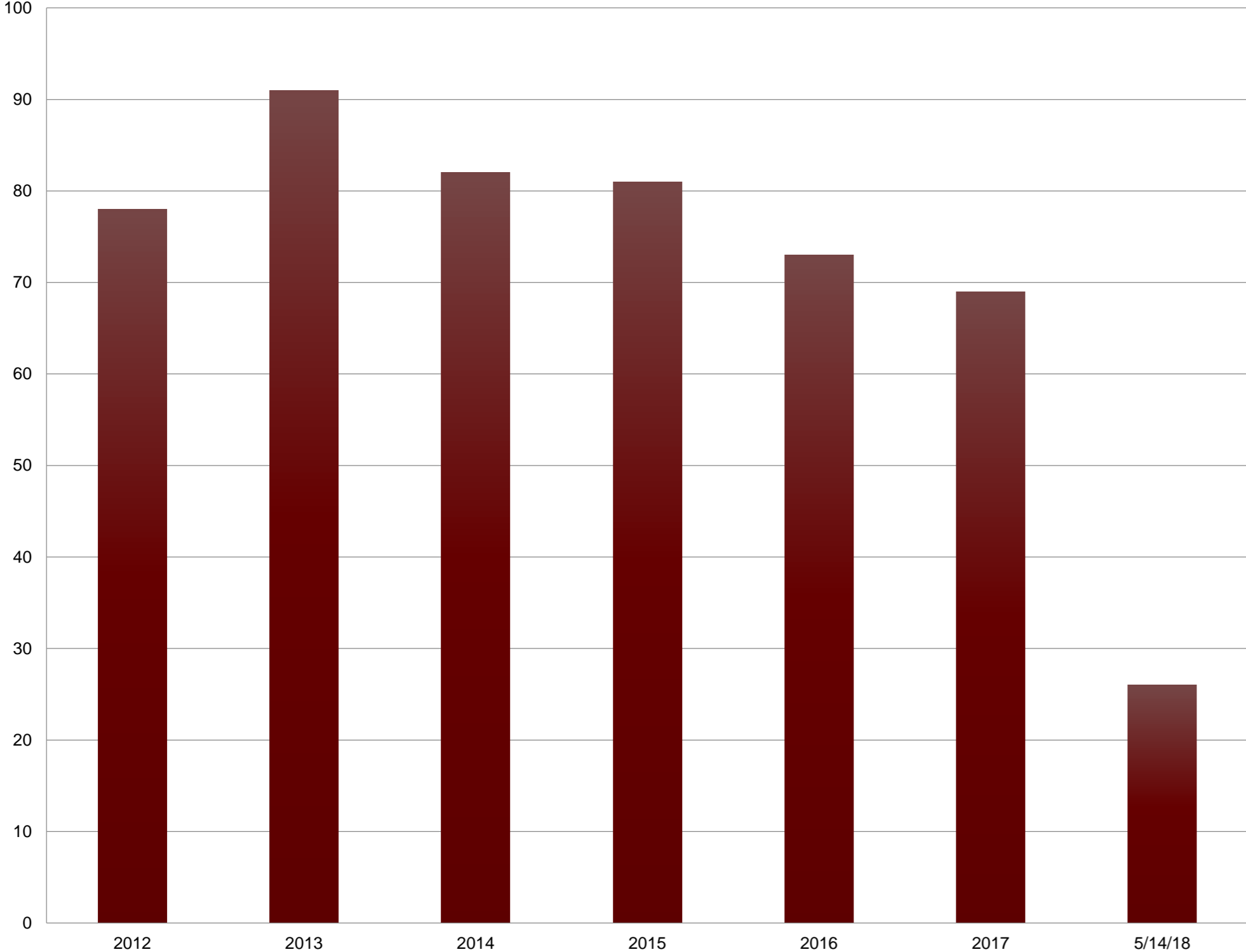

Fig. 4



# Boston Children's Experience

Total Aortic Valve procedures



Ao Valve Reconstruction

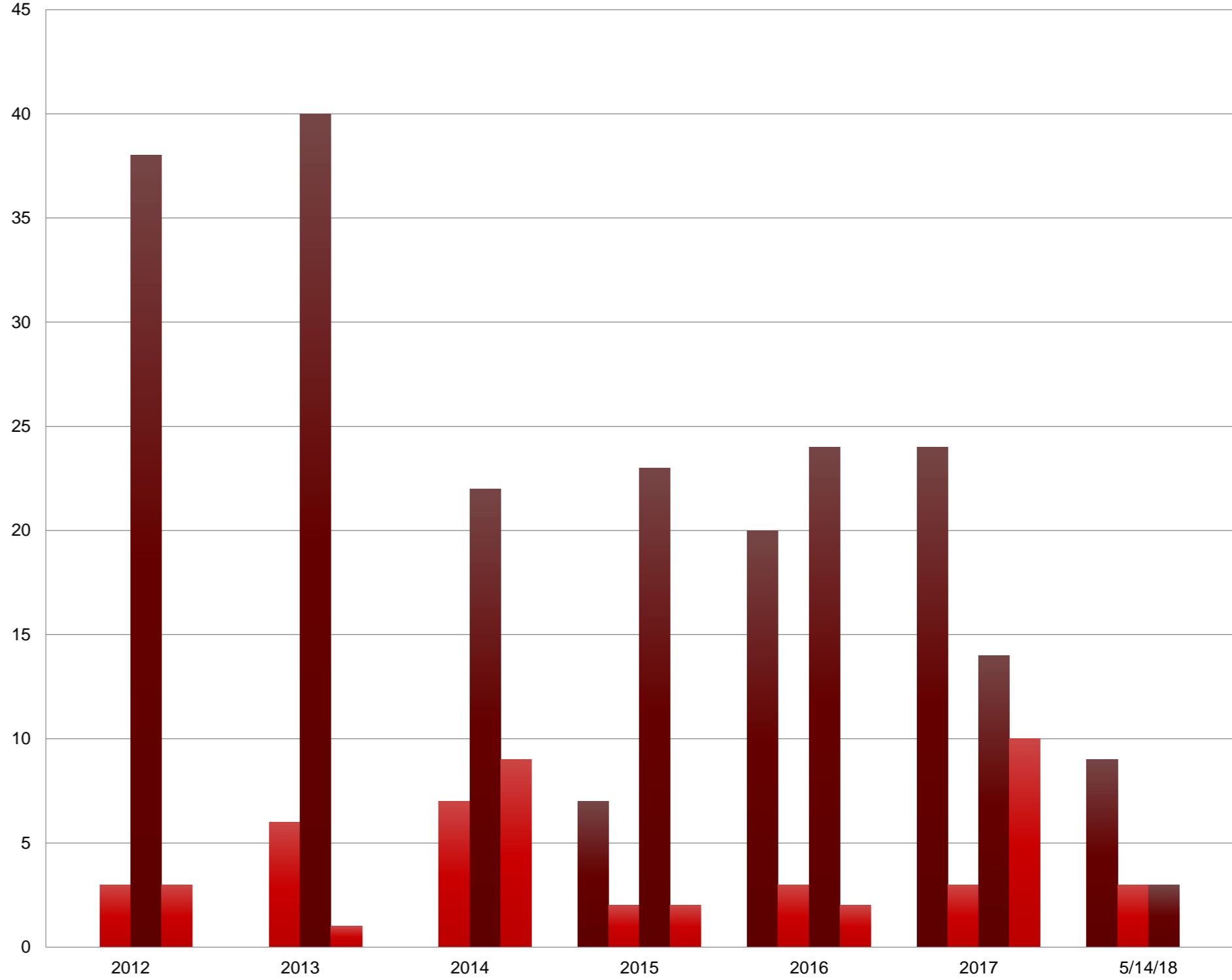

- Ozaki procedures
- NeoAo valve procedures
- Leaflet procedures (non-replacement)
- Valvotomy/Commissuroplasty

# Inspection and Resection

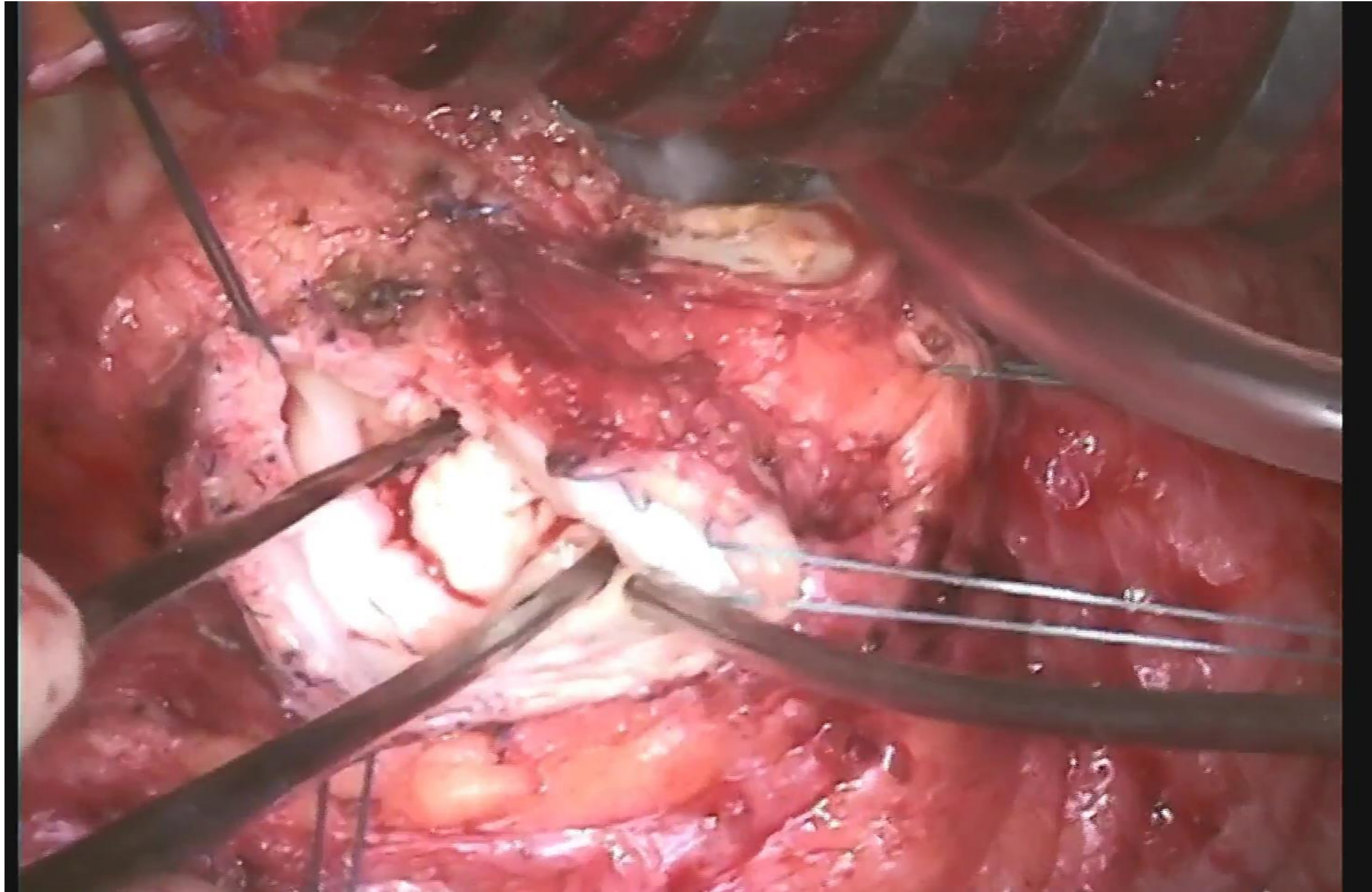

# Marking Commissures

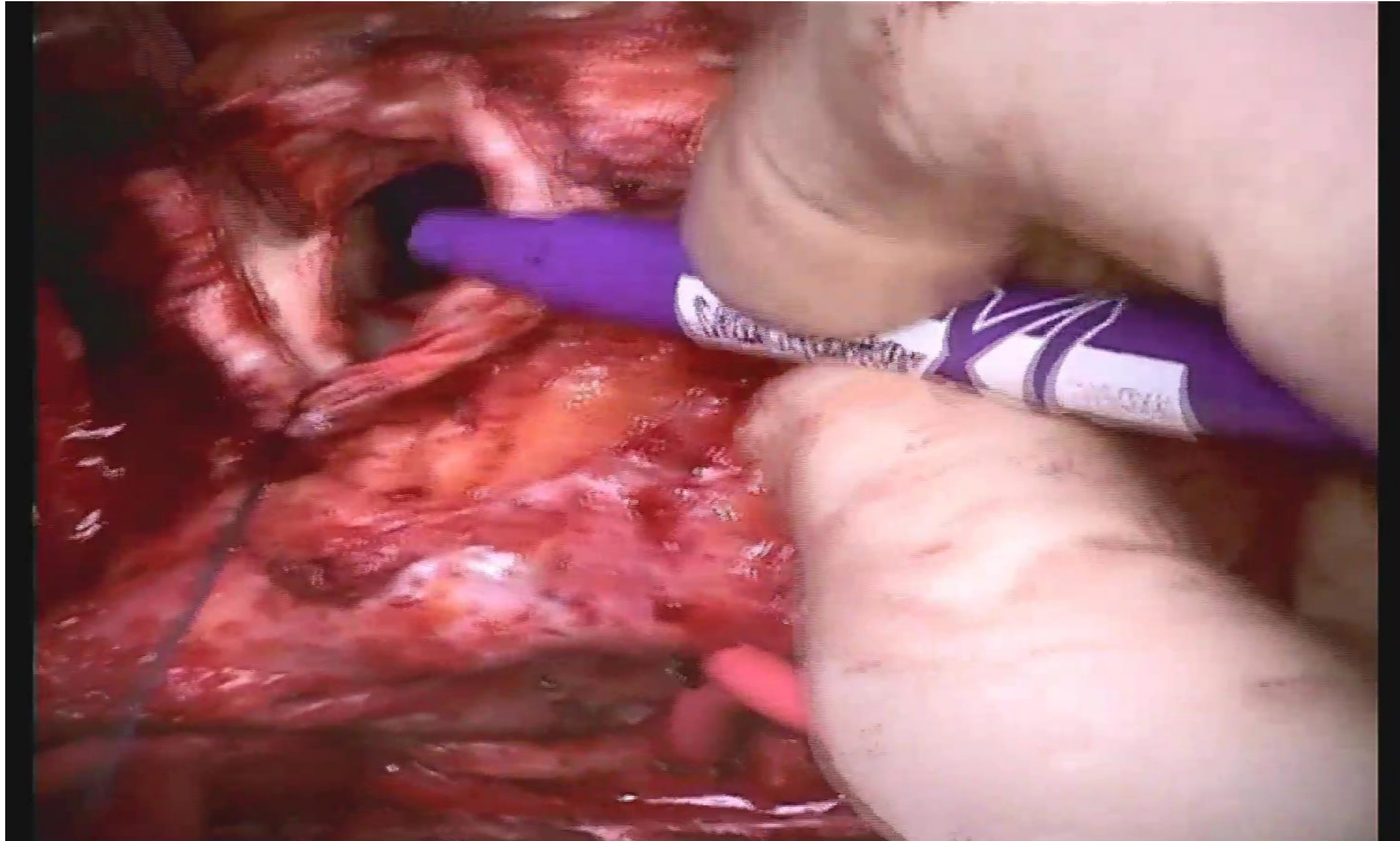



# Sizing Valve Leaflets

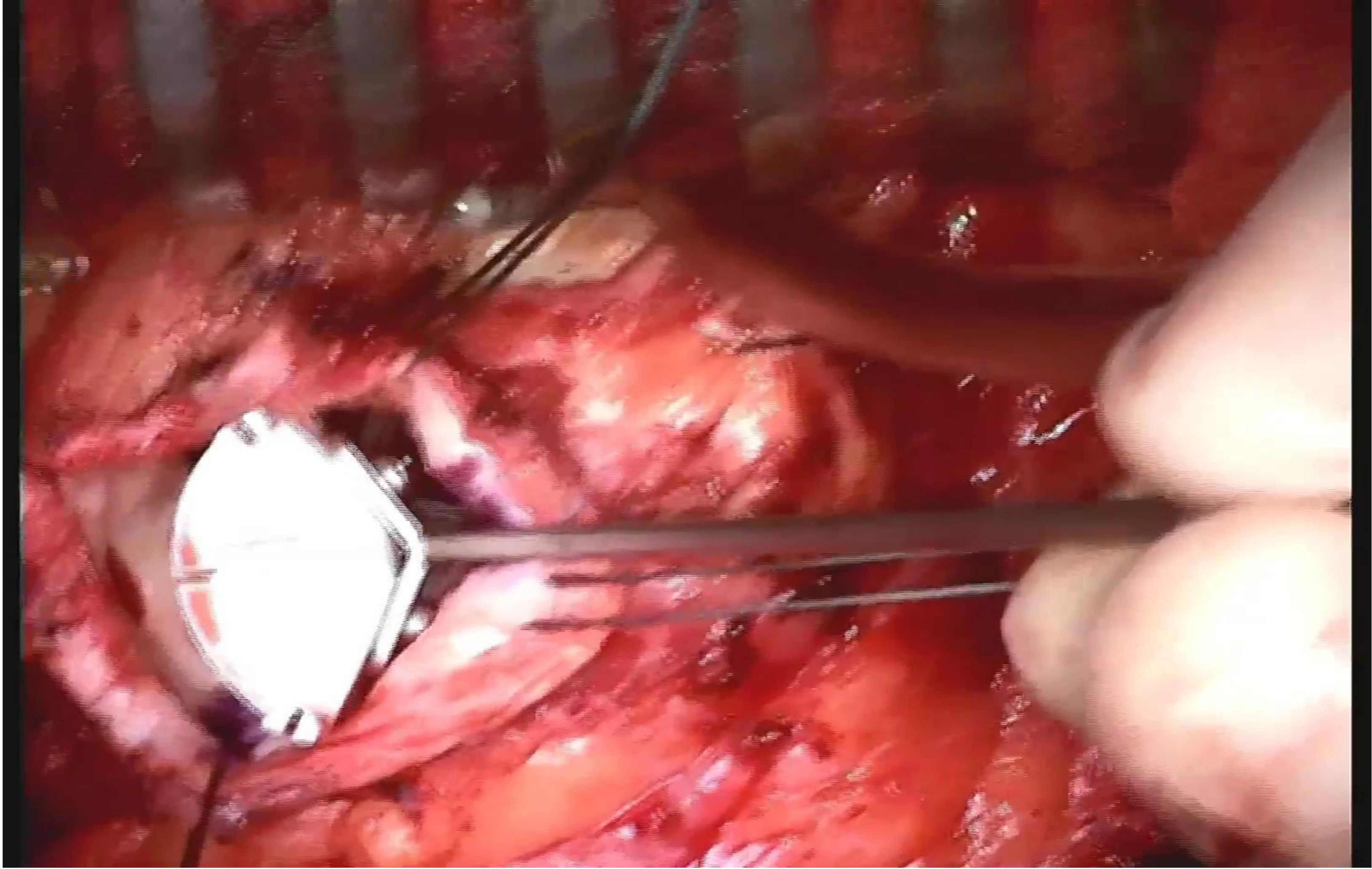
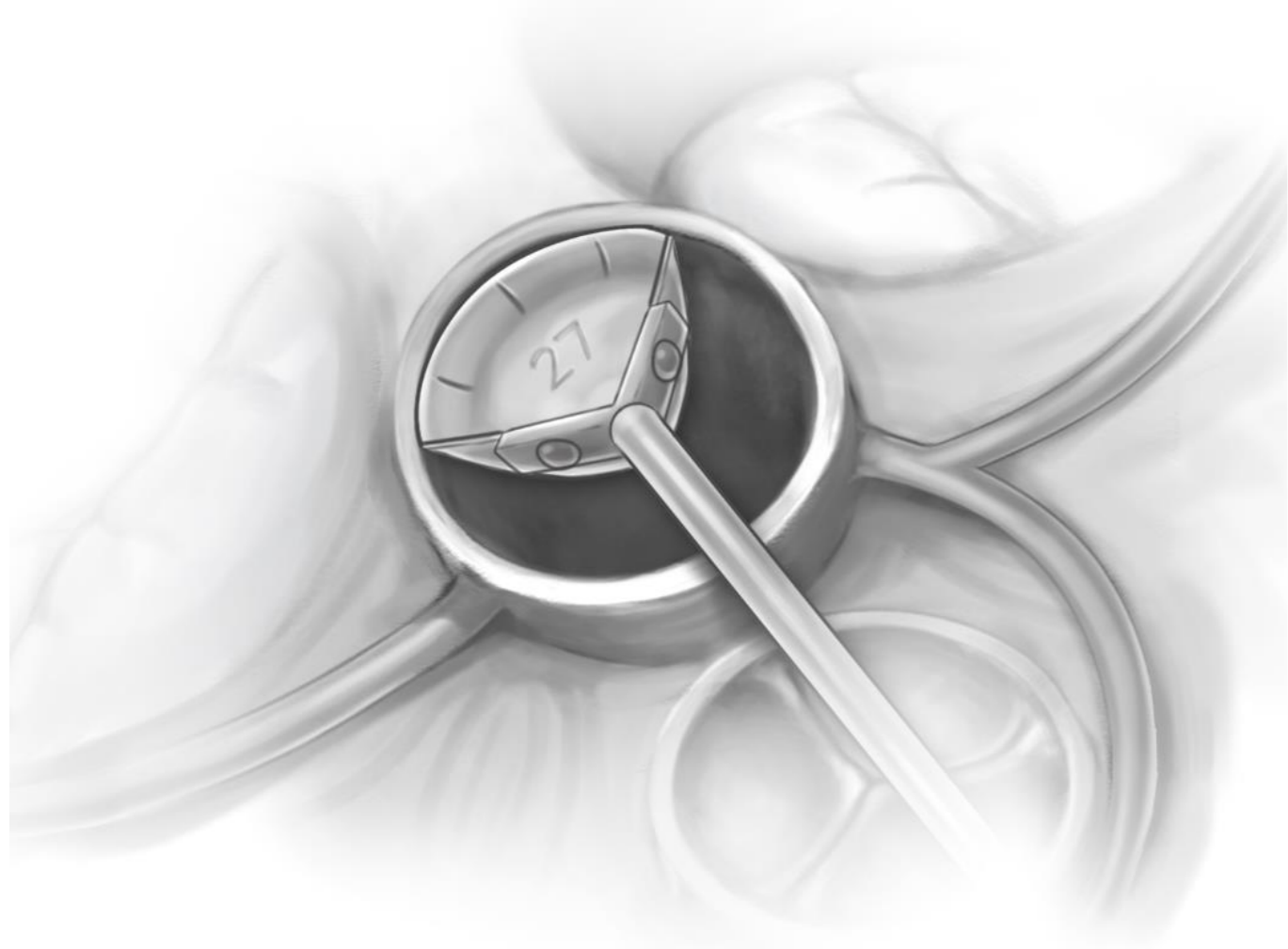
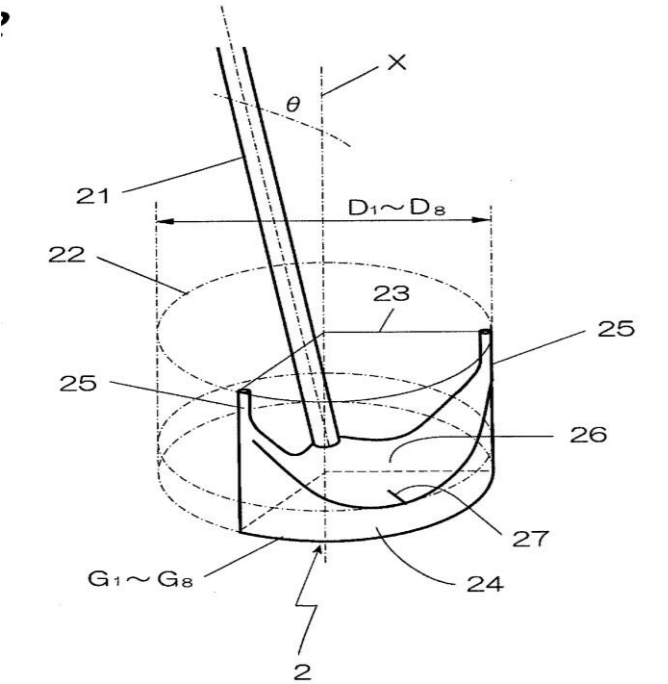

# Marking Templates

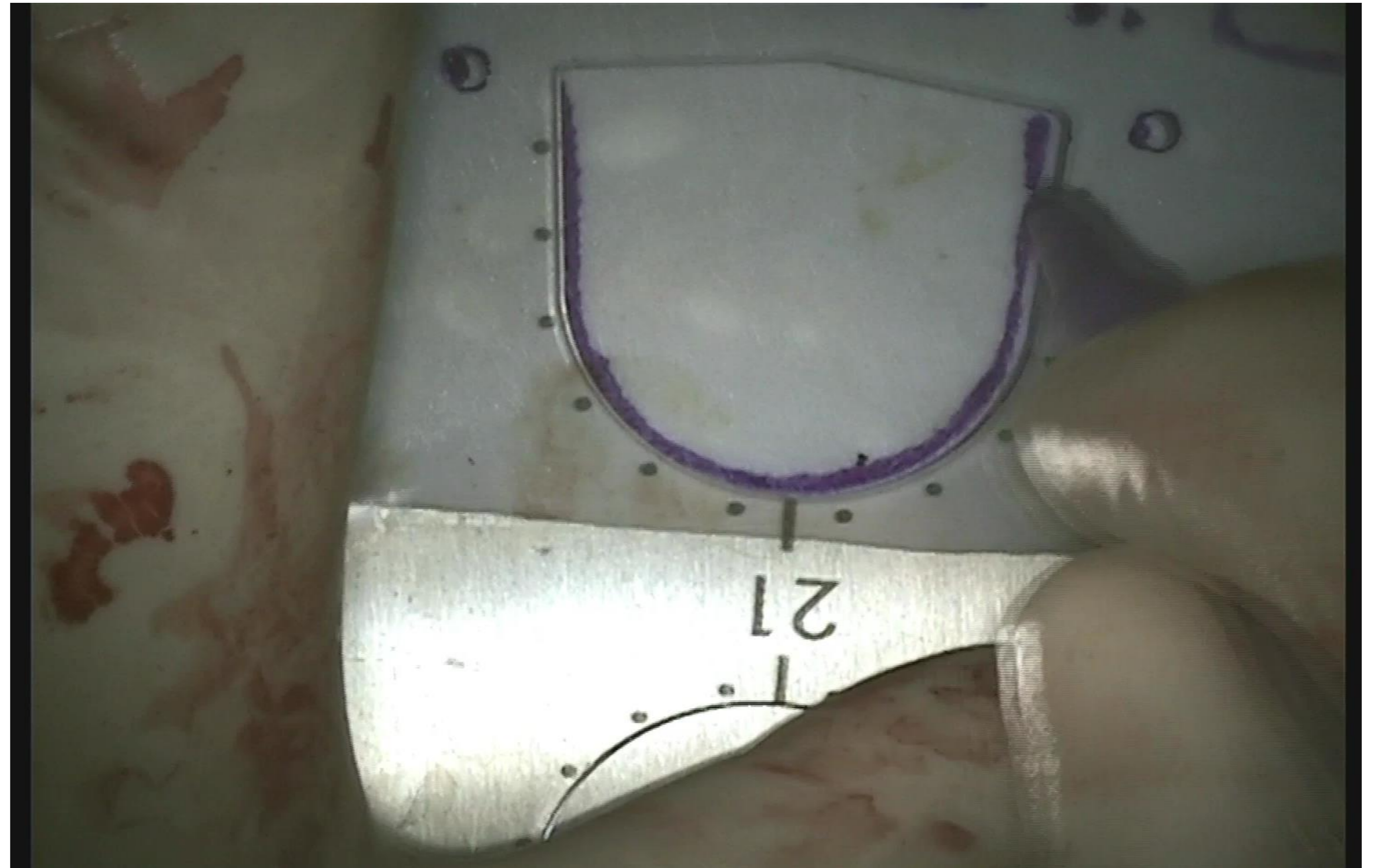
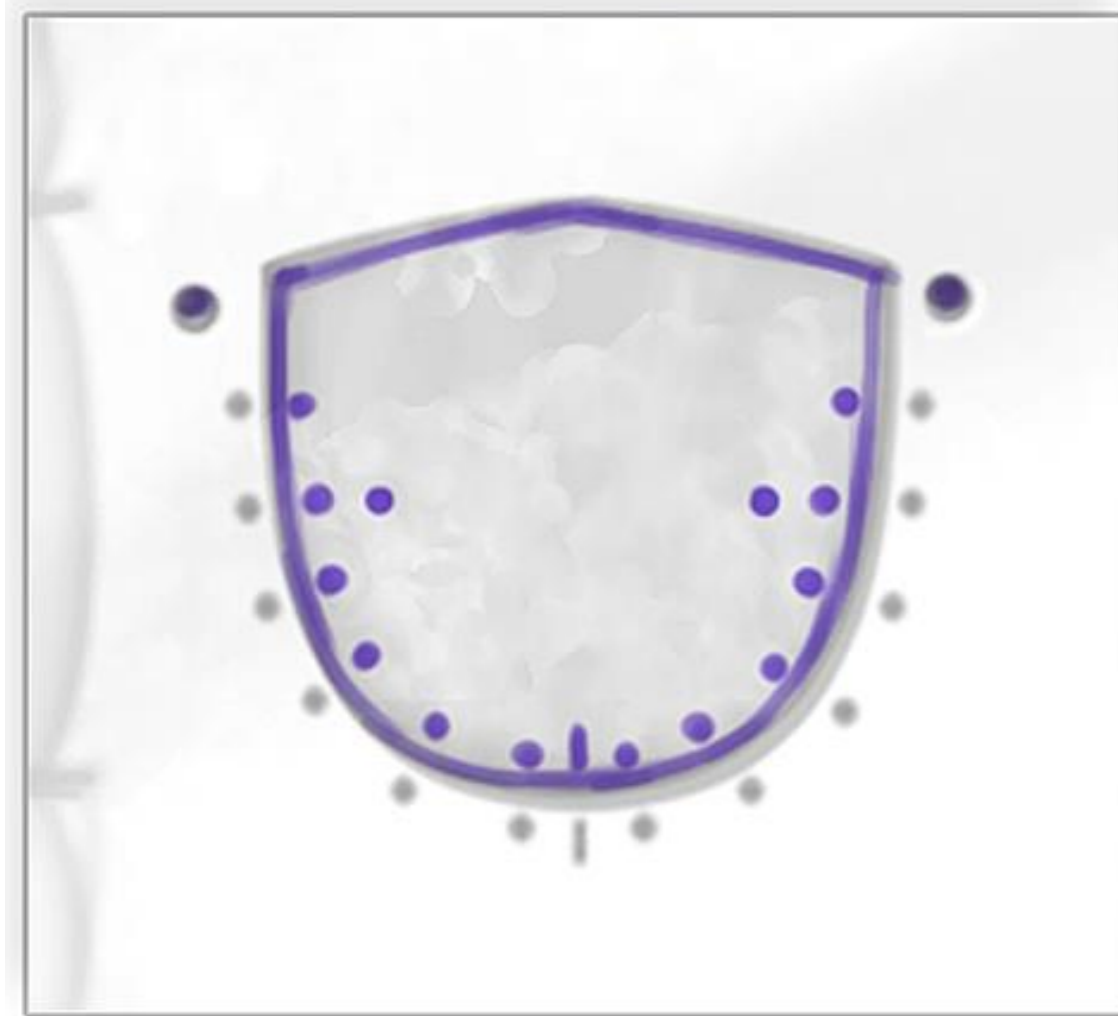
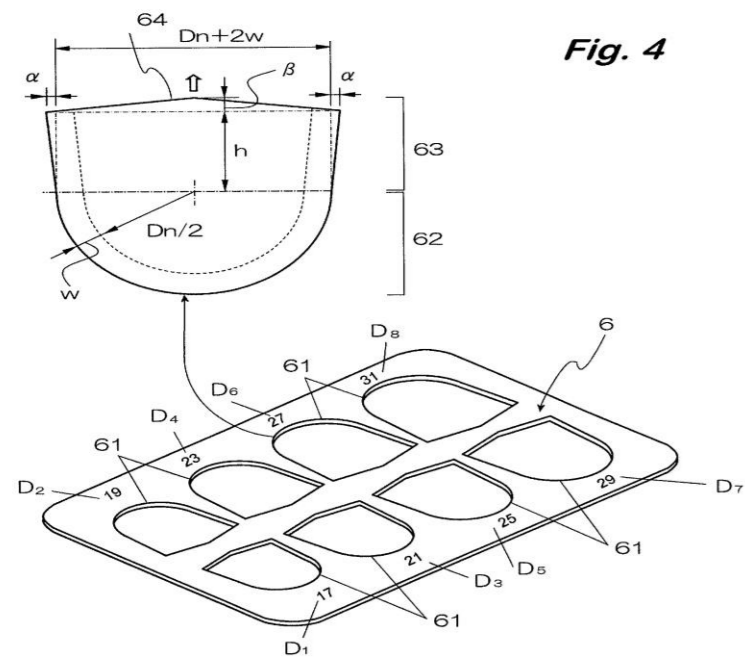

# Tissue substitute material

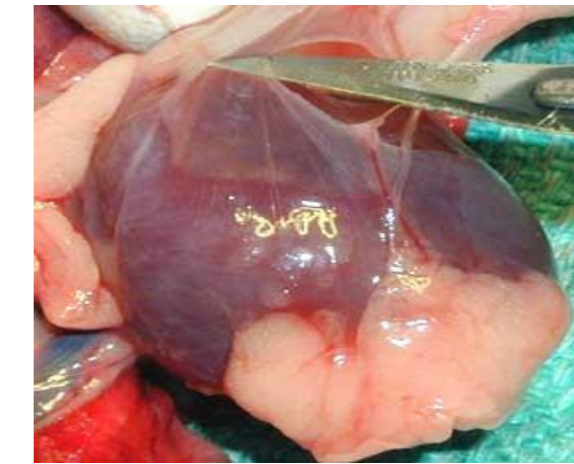

Pericardium

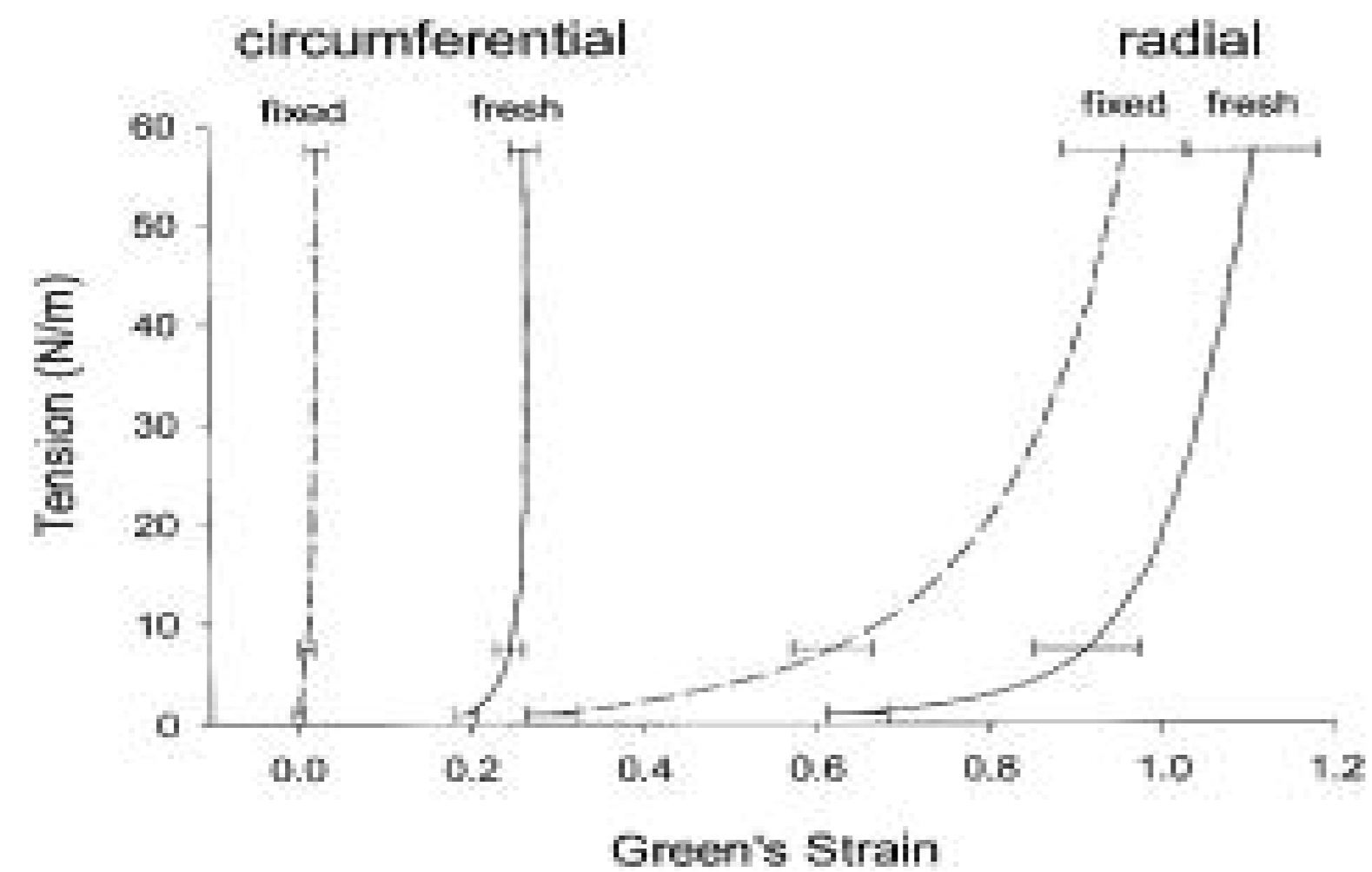

(a)

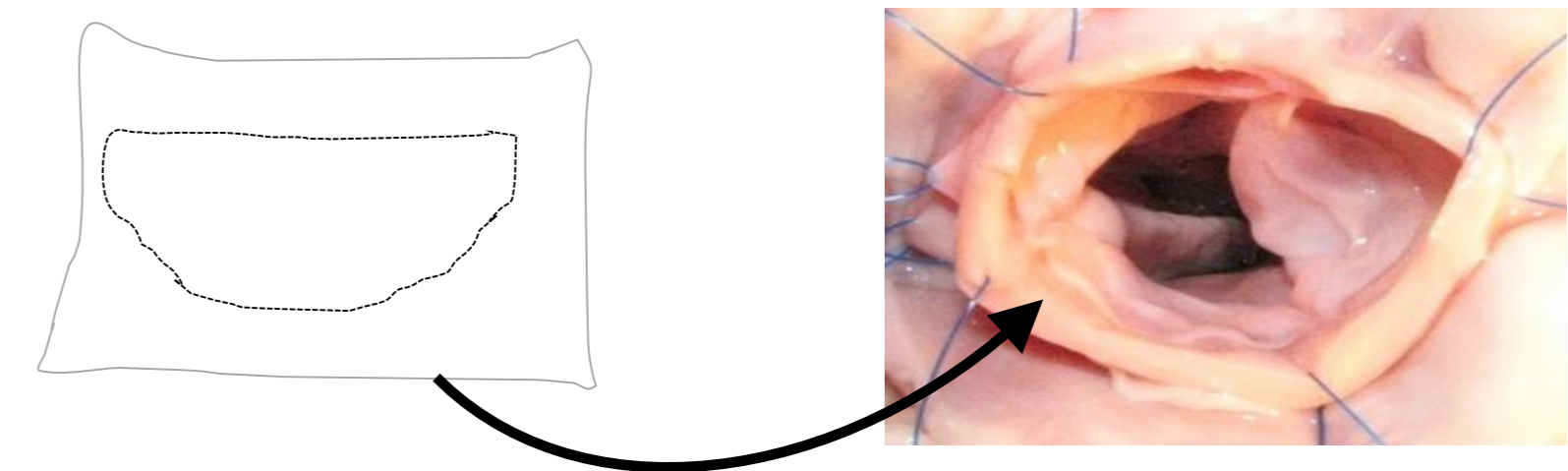

# Suturing 1<sup>st</sup> leaflet

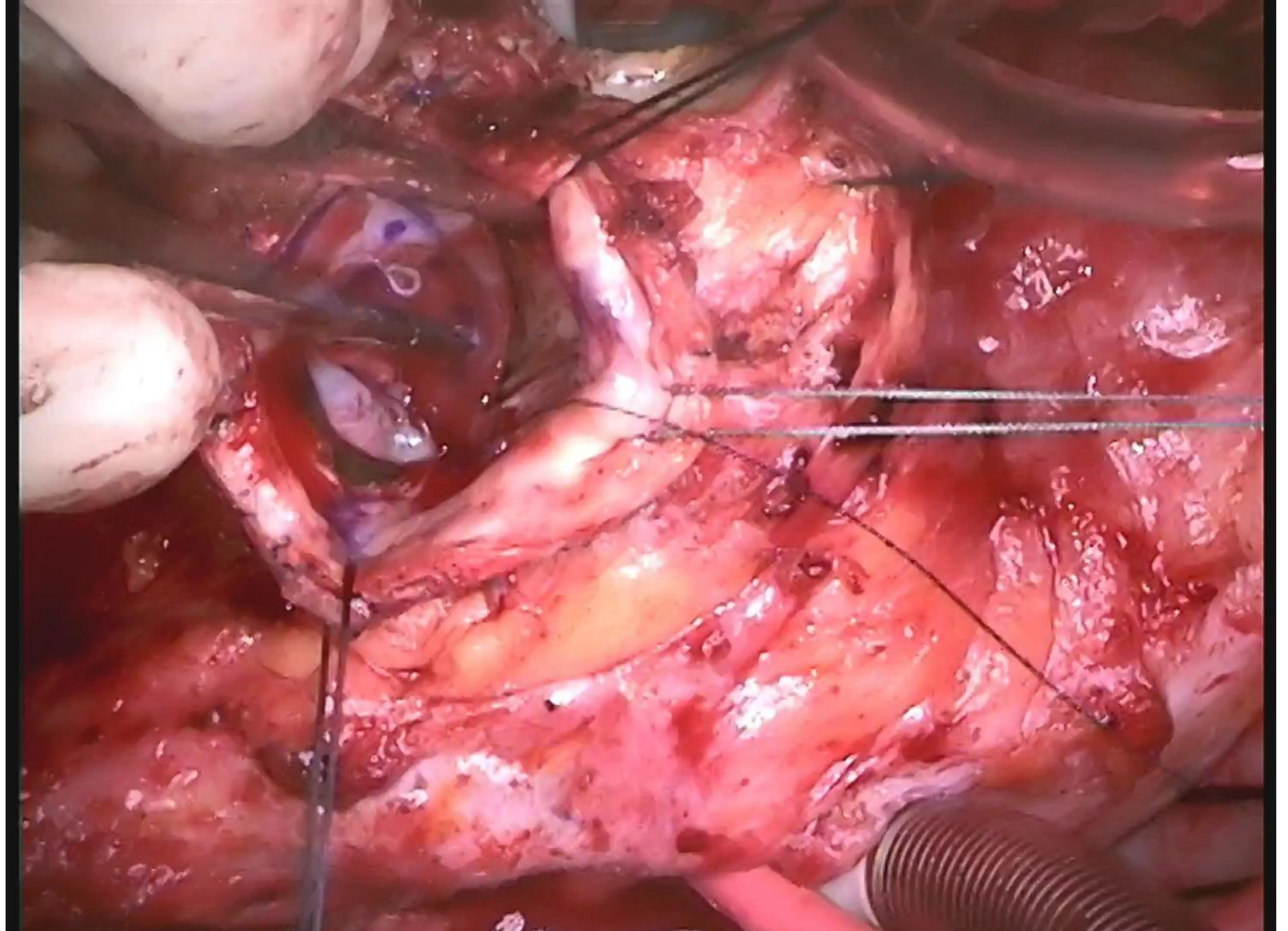
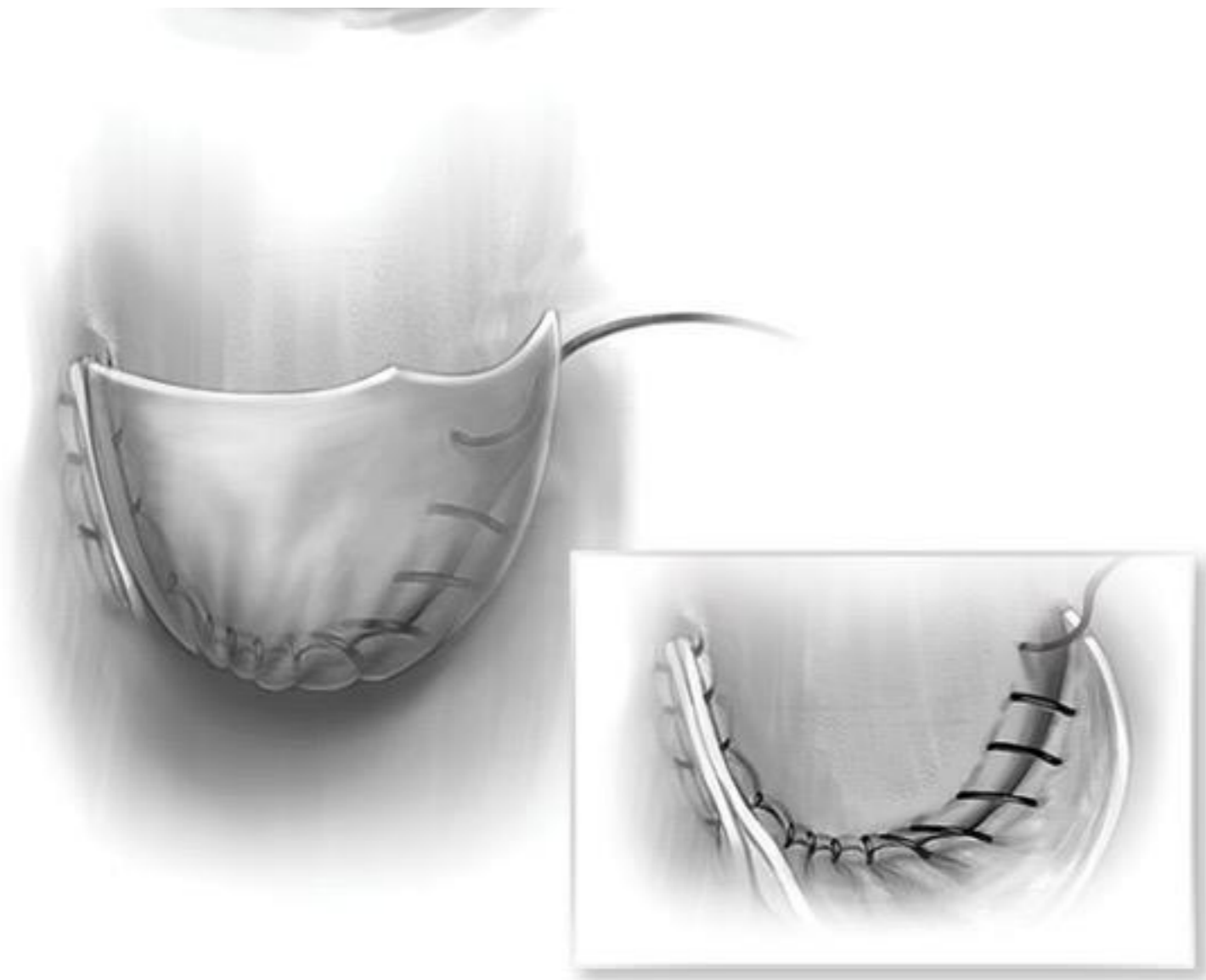

# Second leaflet

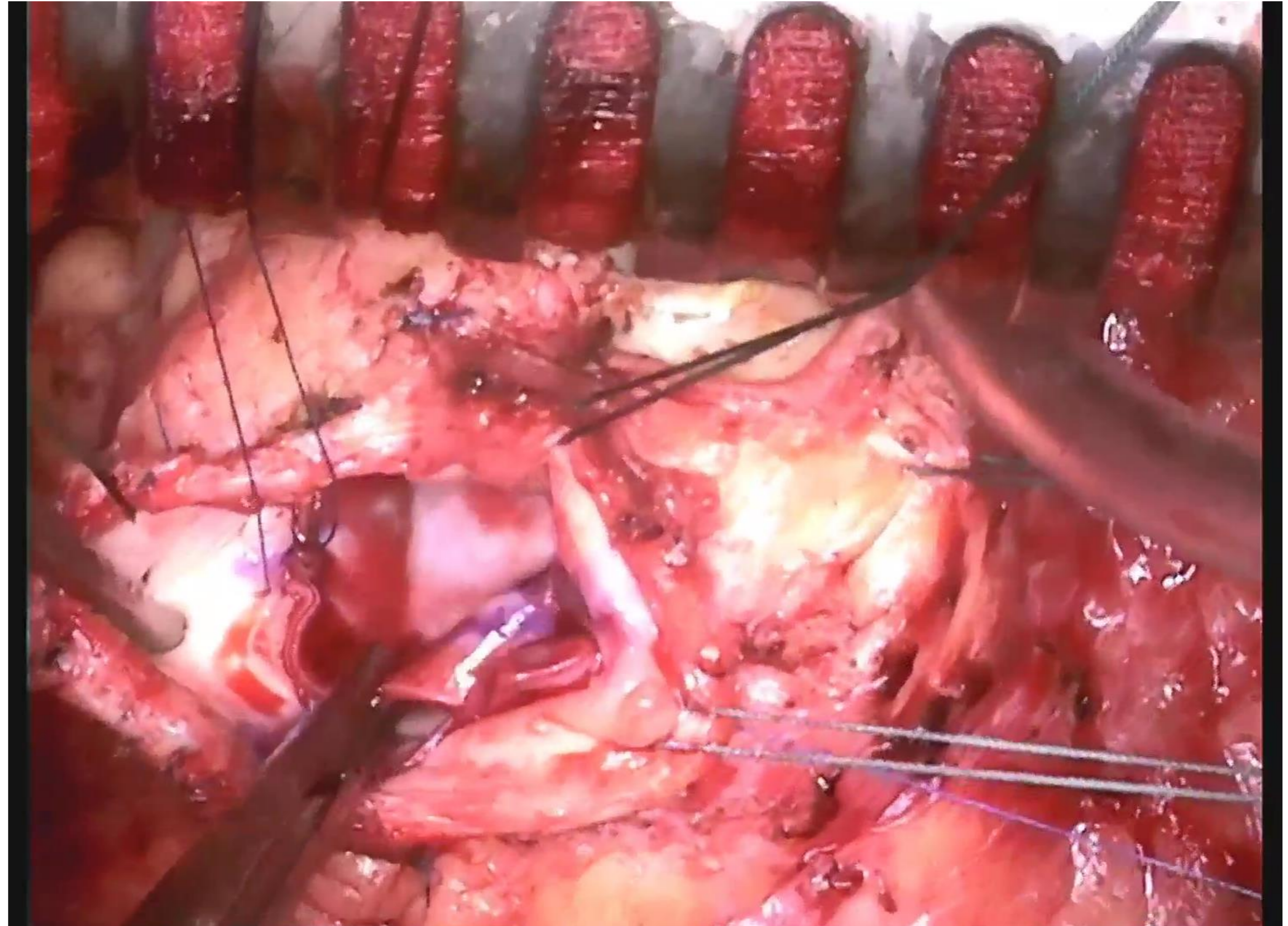
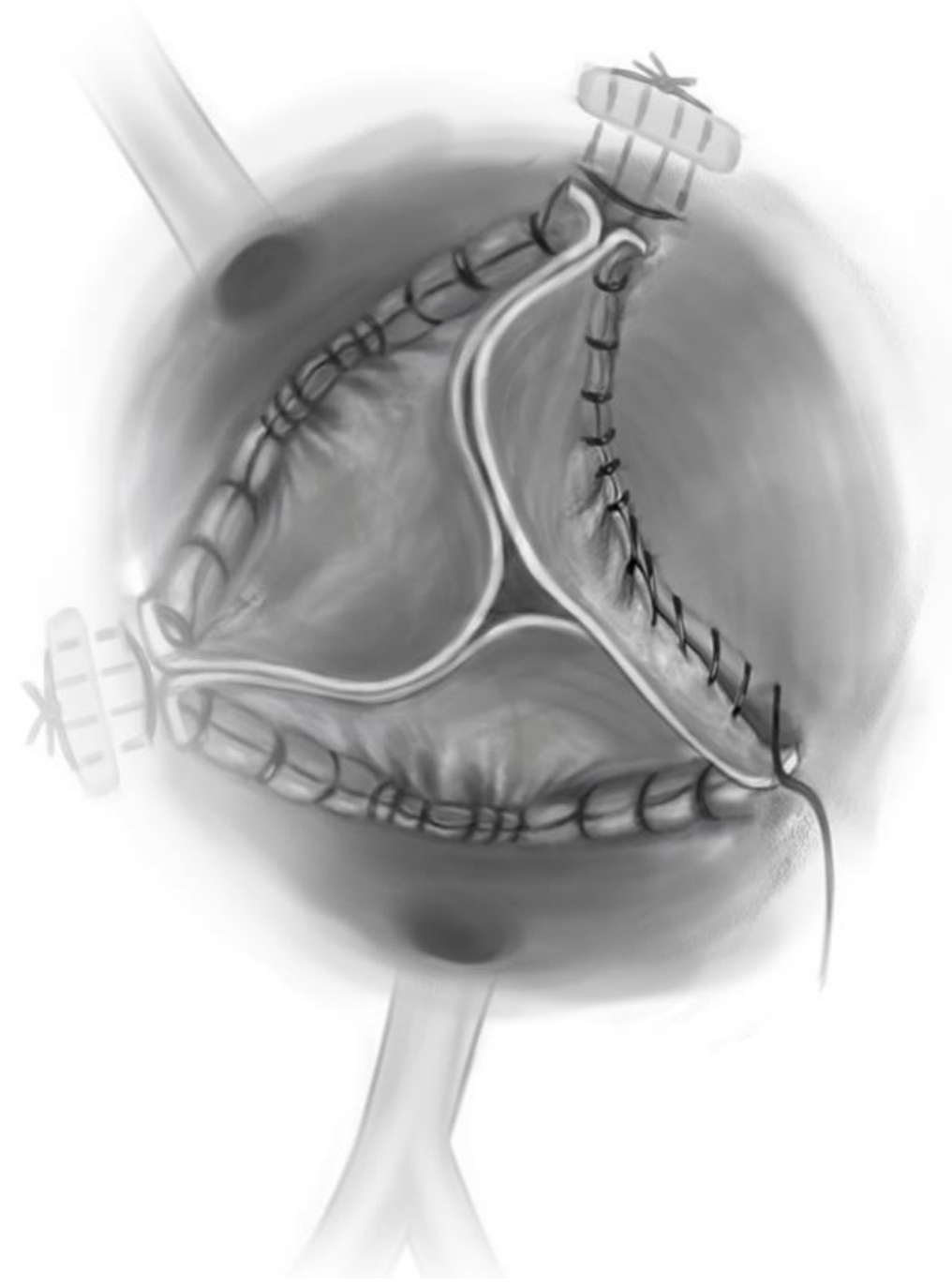

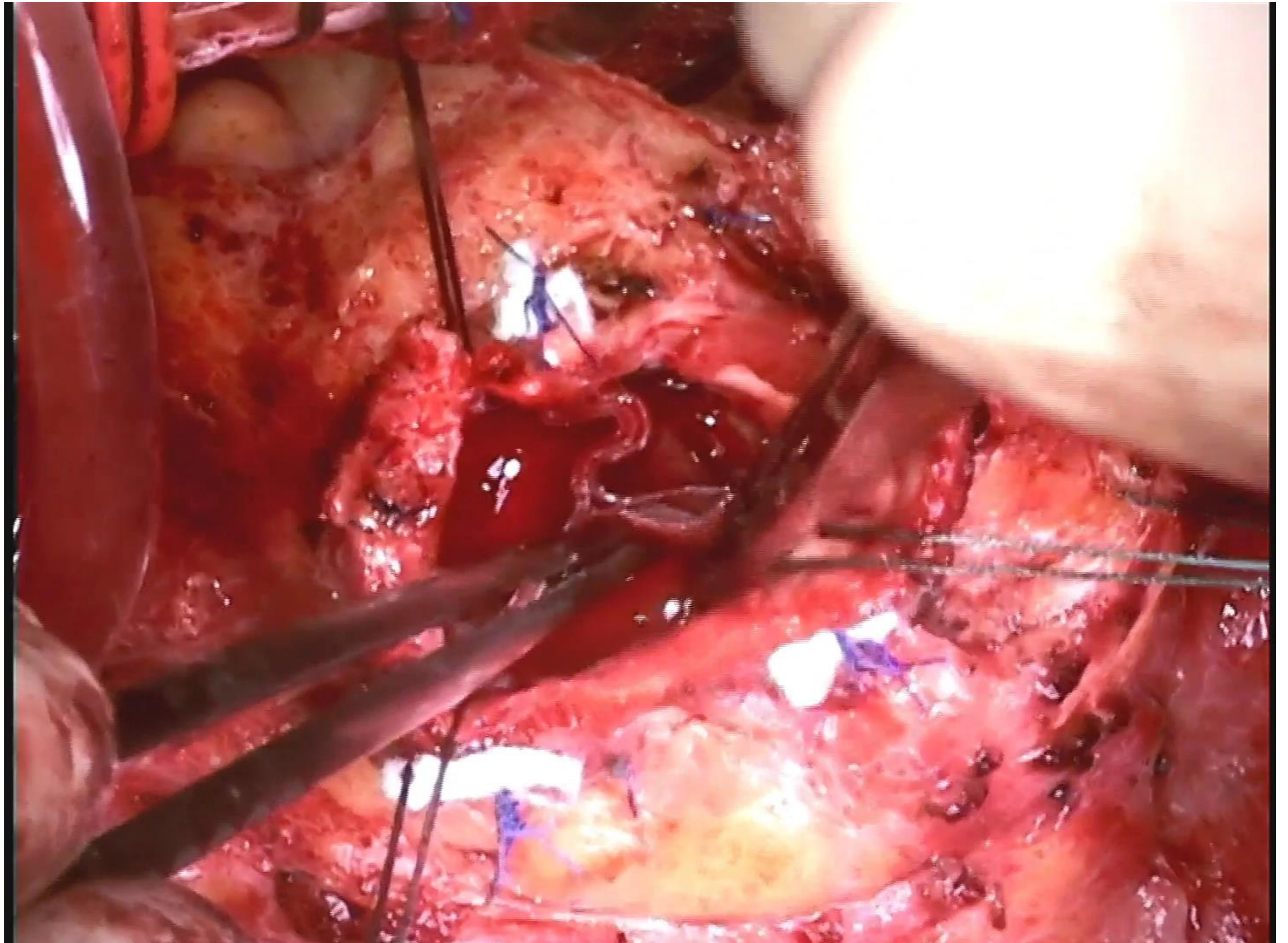
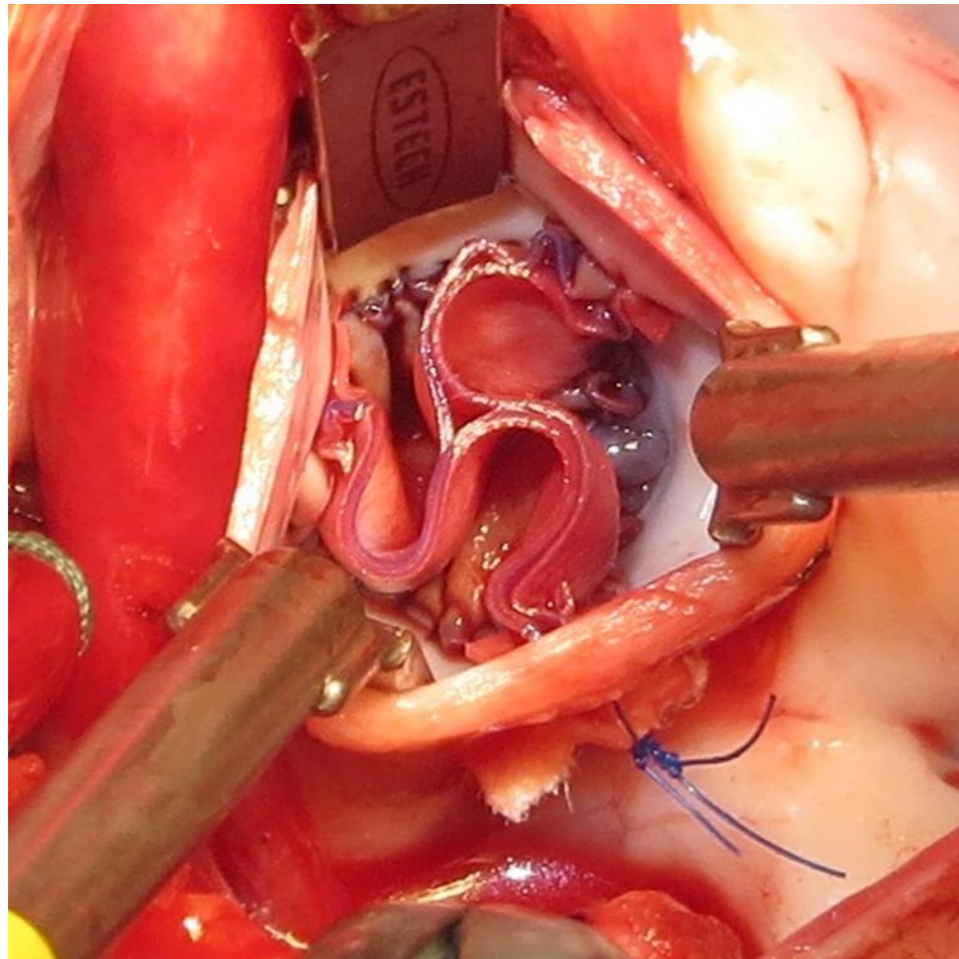

# Single leaflet tear

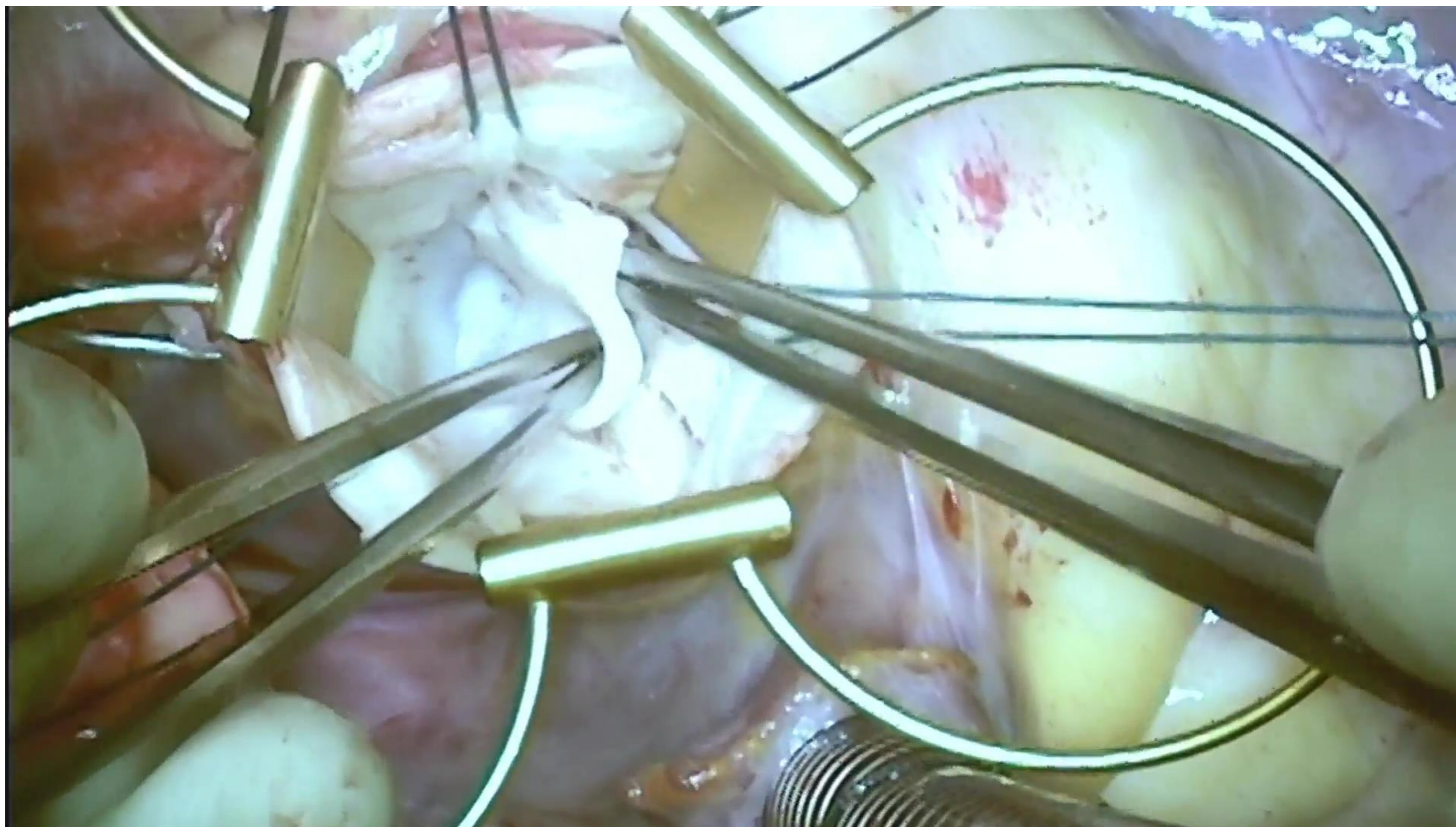

# Suspending Non-coronary Leaflet

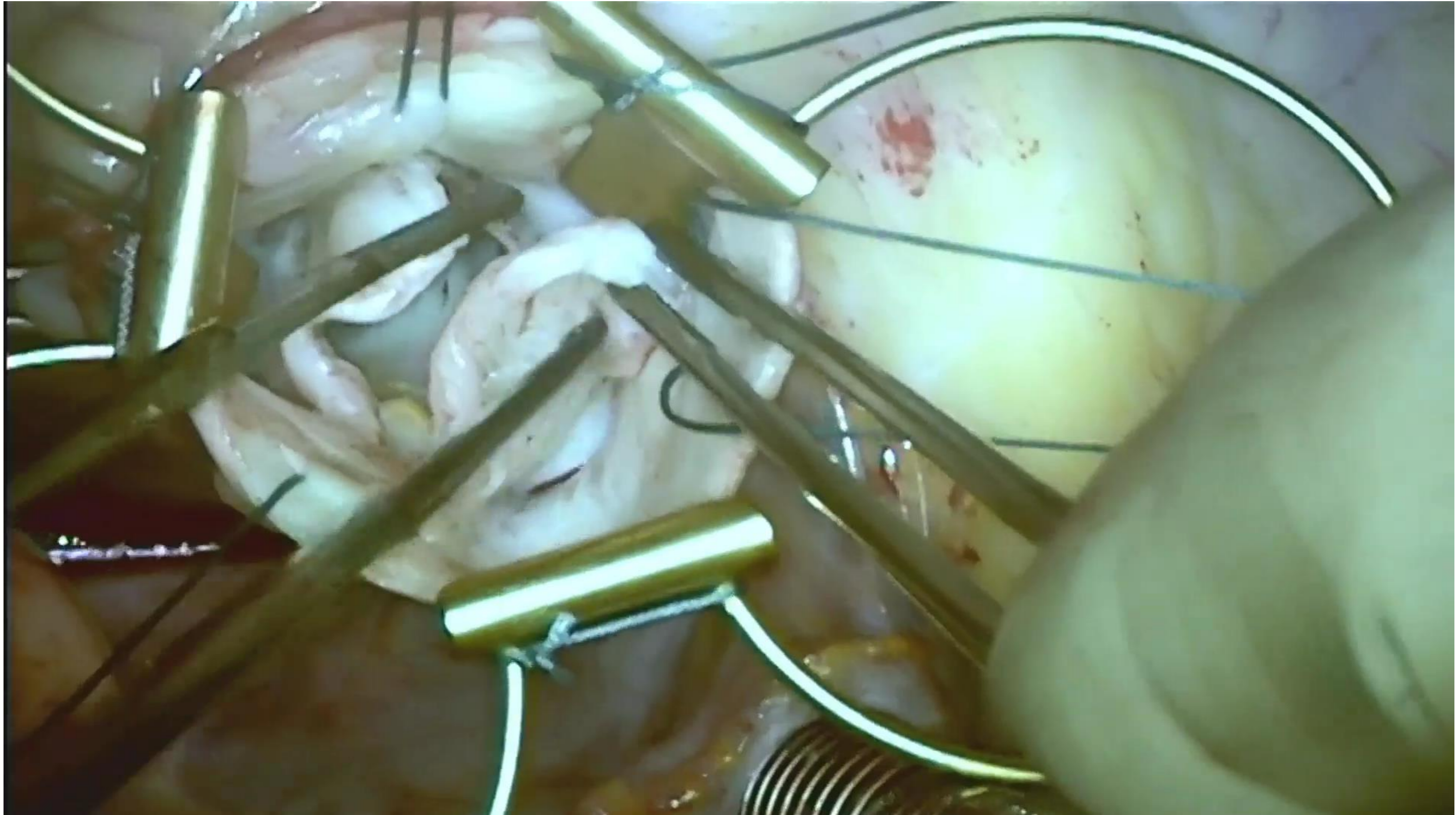



# Sizing Anterior Leaflet

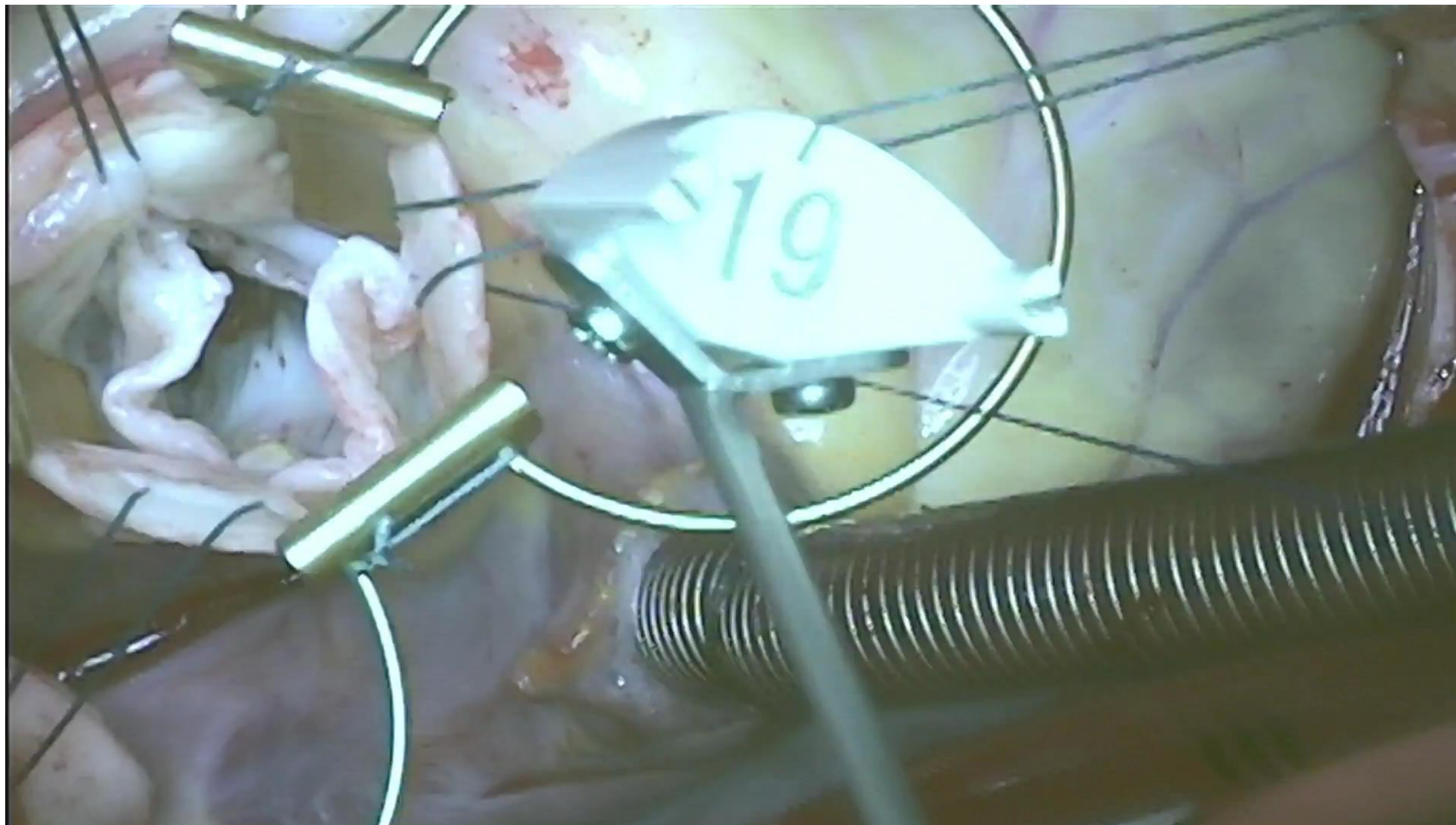

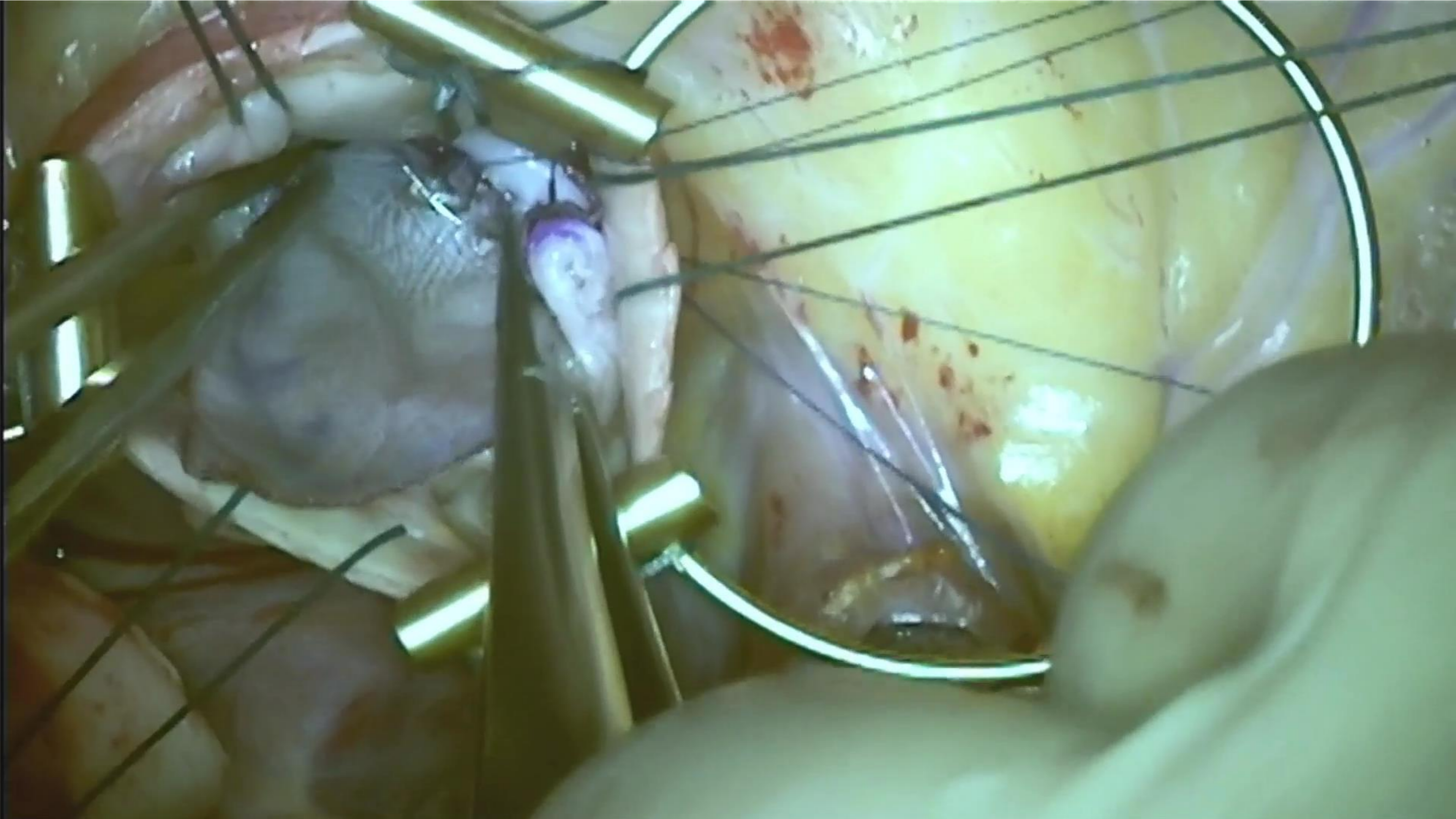

# Final Inspection and Trimming



# Post-operative Echo

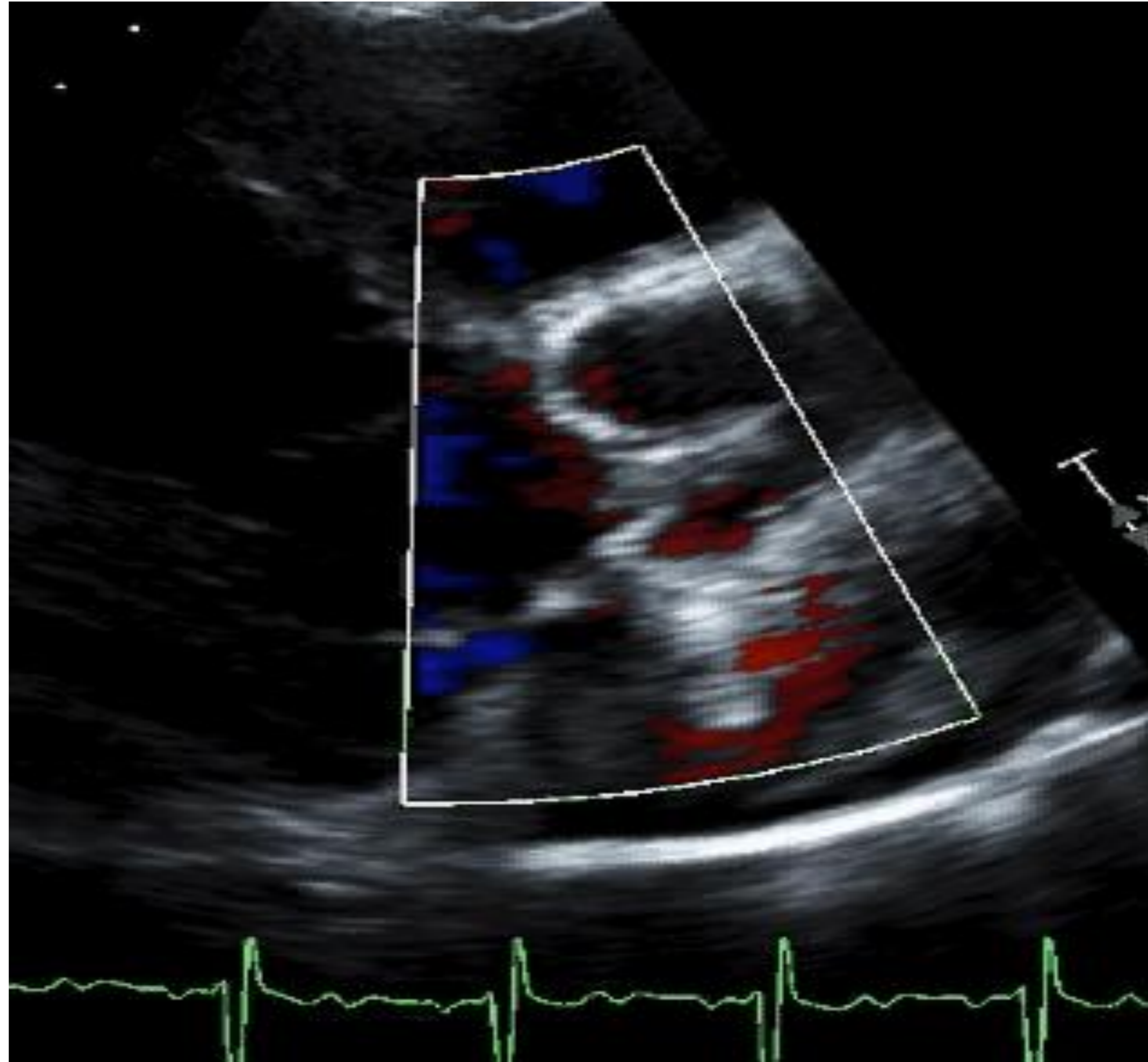

# Root enlargement- Konno and Manougian procedures

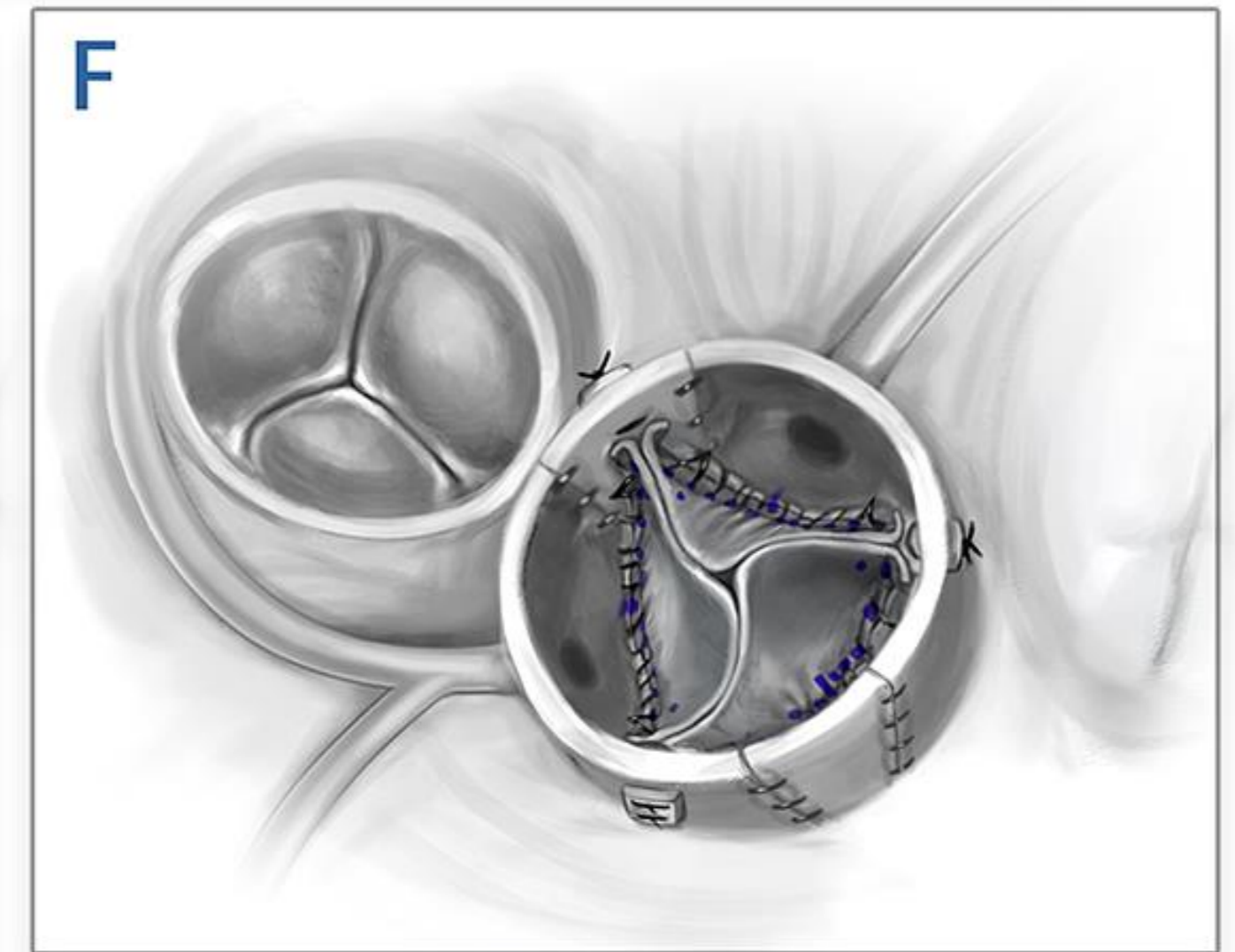
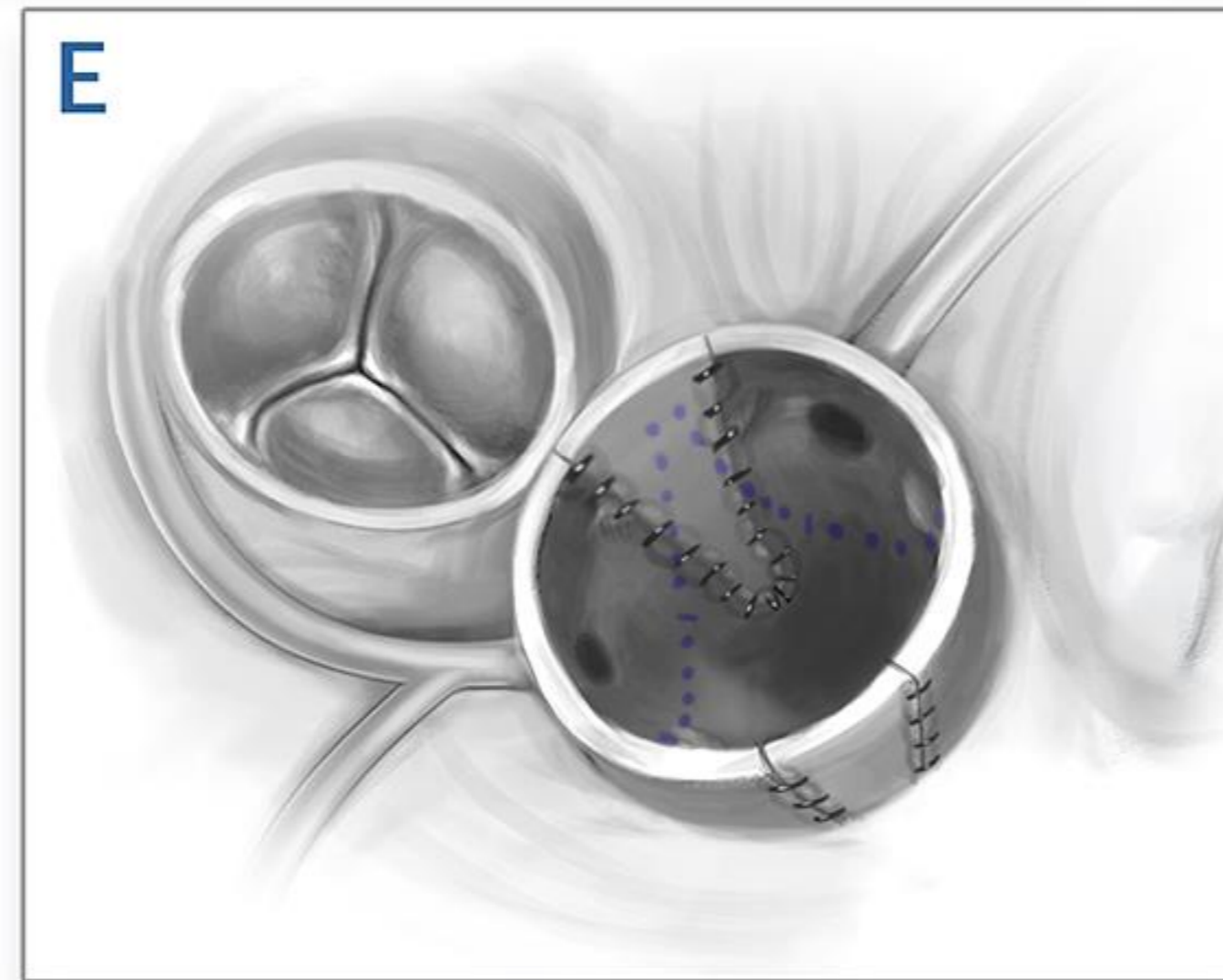
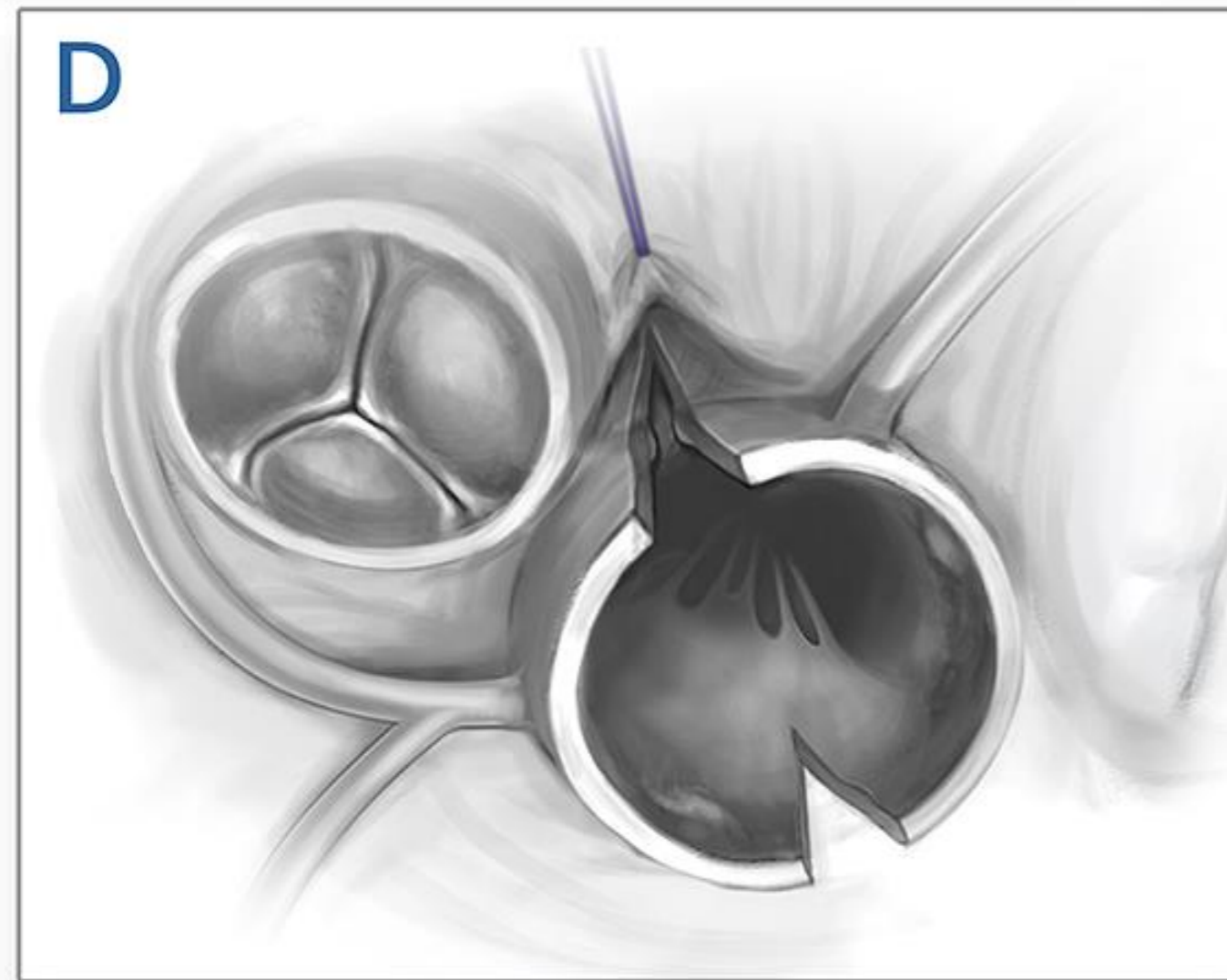
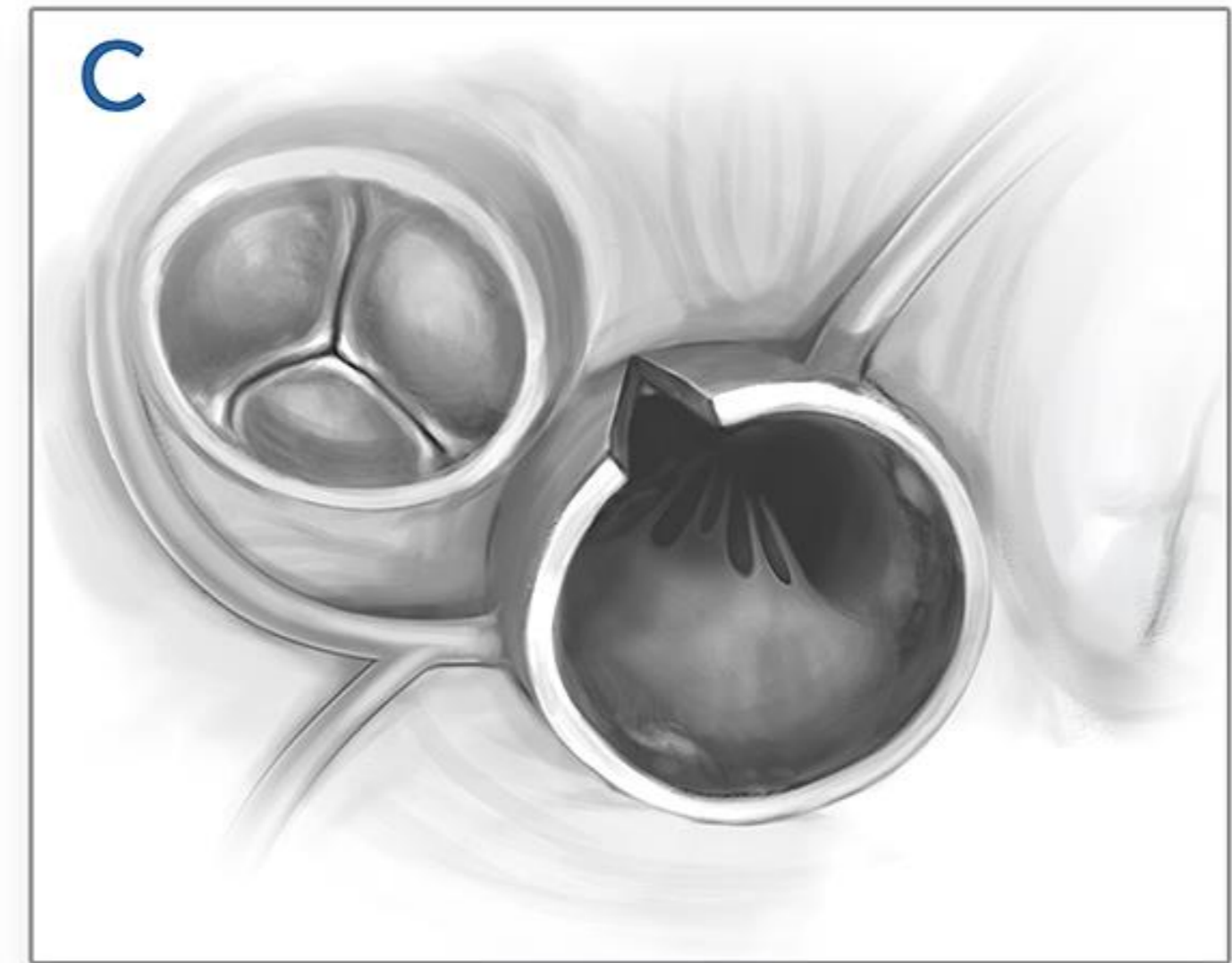
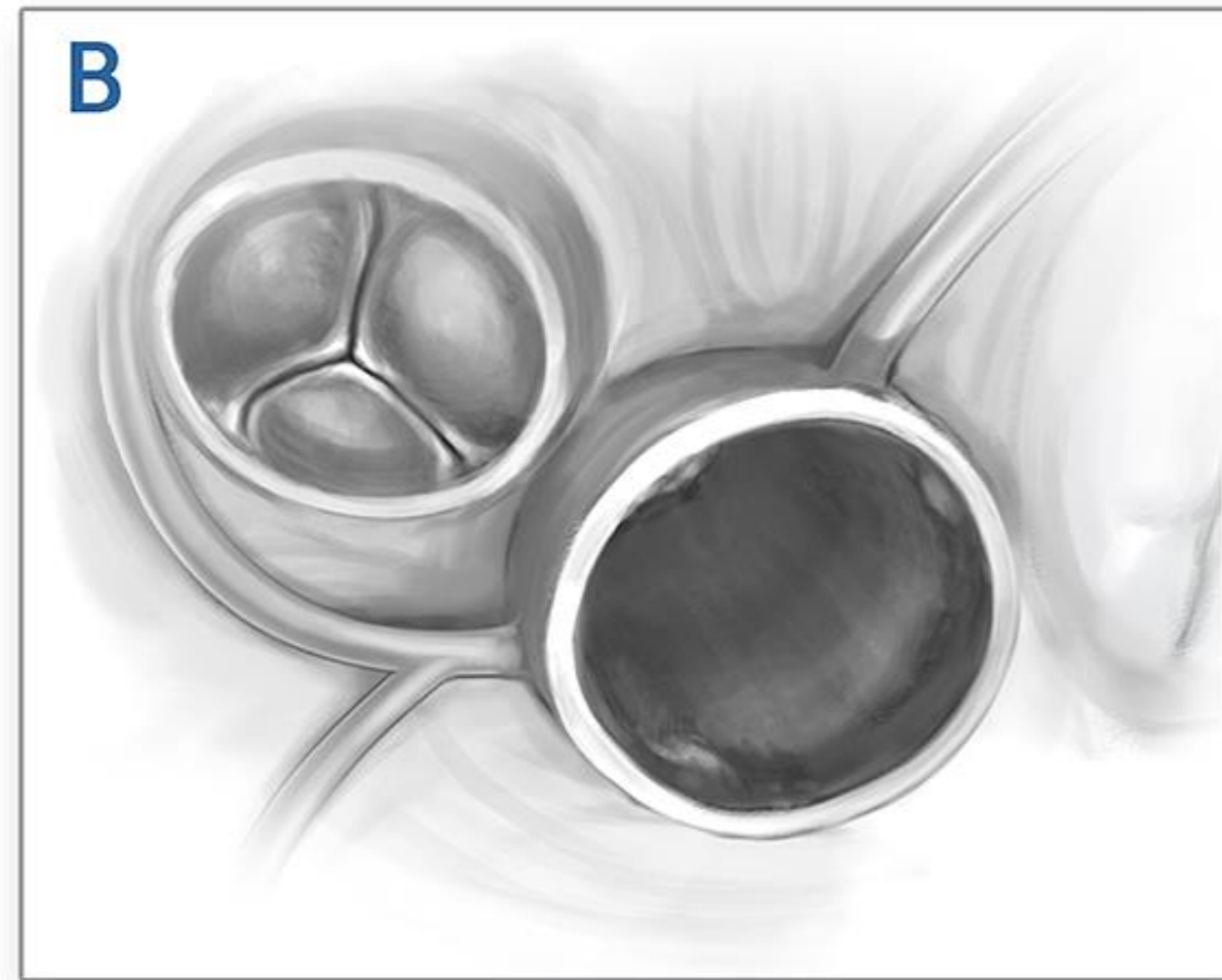
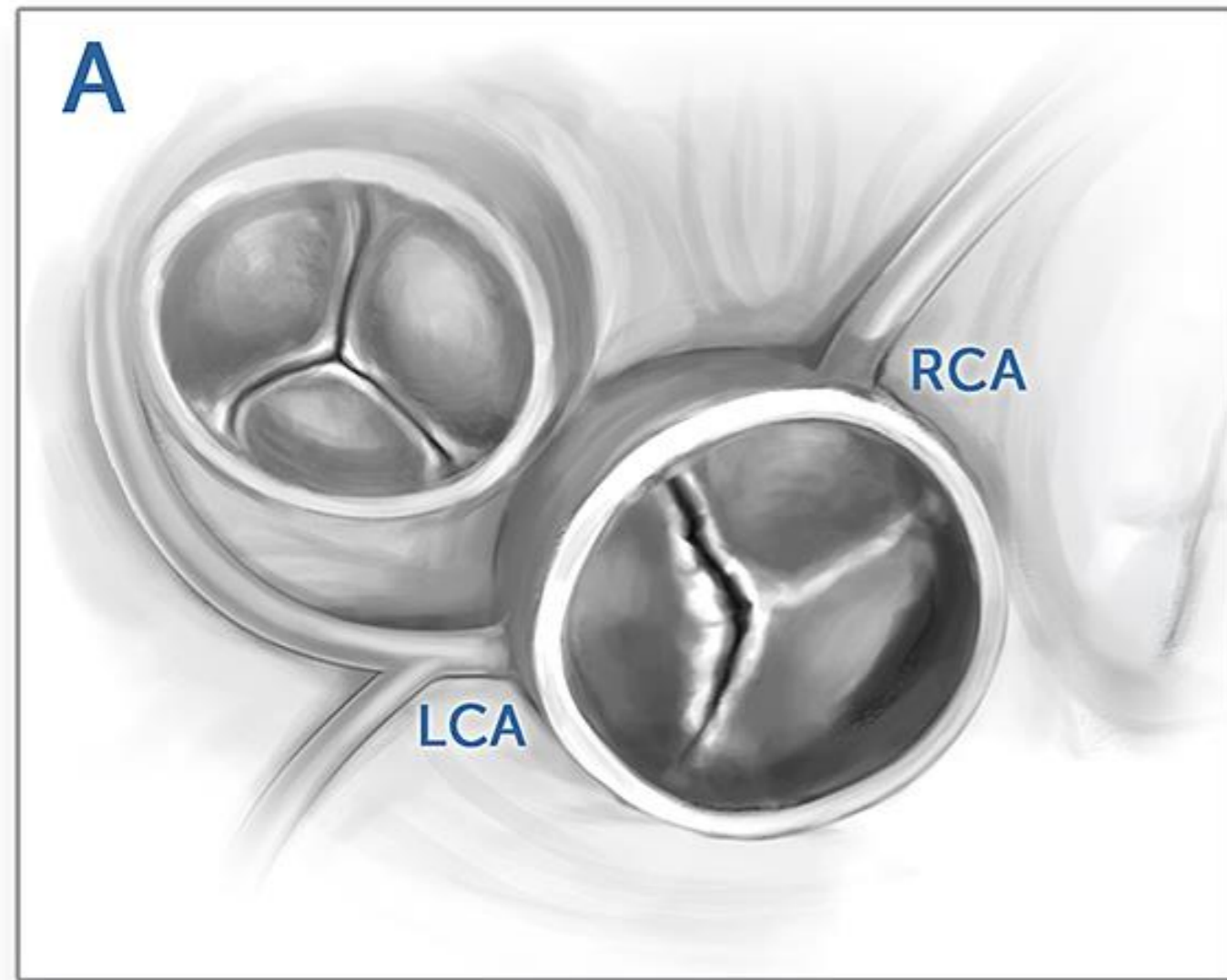

**Thank you**